

igoto®



2024

CATÁLOGO

ILUMINACIÓN / PLACAS / ARTEFACTOS / VENTILADORES / MECANISMOS / BOMBAS / SOLDADORAS



igoto



ENCUENTRA
TODO
PARA TU HOGAR



▶ **ÍNDICE** AXOLIGHT

PLACAS APAGADORES Y MECANISMOS

- 05-07** LÍNEA SMARTHOME
- 08-12** LÍNEA INOX
- 13-22** LÍNEA LUGANO PLUS
- 22-30** LÍNEA STYLE PLUS
- 30-32** ZURICH PLUS
- 33-43** APAGADORES Y MECANISMOS

ARTEFACTOS Y PRODUCTOS ELÉCTRICOS

- 44-52** ARTEFACTOS ELÉCTRICOS
- 52** EXTENSIONES
- 53** INTERRUPTORES TERMOMAGNÉTICOS
- 54** EXTRACTORES

ILUMINACIÓN

- 55-56** FOCOS LED E27
- 57-58** PAQUETE FOCOS LED E27
- 59-61** FOCOS LED ALTA POTENCIA
- 62-63** FOCOS LED DICROICOS
- 64-65** LUMINARIOS DOWNLIGHT
- 66-67** TUBOS Y REGLETAS
- 68-69** GABINETES Y LUMINARIOS LED
- 70** LUMINARIO STREET LIGHT LED
- **71-75** REFLECTORES LED

VENTILACIÓN

ILUMINACIÓN

- **76-83** VENTILADORES



➤ ÍNDICE NOVATEK

BOMBAS HIDRÁULICAS	<input type="checkbox"/>	90 BOMBA DE PRESIÓN CONSTANTE 91-92 BOMBAS PERIFÉRICAS 93-94 BOMBAS CENTRÍFUGAS
TANQUES HIDRONEUMÁTICOS	<input type="checkbox"/>	95-96 TANQUES HIDRONEUMÁTICOS
AUTOMÁTICOS PARA BOMBAS MOTO BOMBA 97	<input type="checkbox"/>	96-97 AUTOMÁTICOS MOTOBOMBAS
AUTOMATICOS Y PRESURIZADORES	<input type="checkbox"/>	97-98 AUTOMÁTICOS Y PRESURIZADORES
BOMBA SUMERGIBLE BOMBA TIPO BALA	<input type="checkbox"/>	99-101 SUMERGIBLES 102-103
COMPRESORES DE AIRE	<input type="checkbox"/>	104-105 COMPRESORES
SOLDADORAS	<input type="checkbox"/>	106-108 SOLDADORAS / CARETAS
REFACCIONES	<input type="checkbox"/>	106-108 REFACCIONES

➤ ÍNDICE DE ÍCONOS **IGOTO** ➤

	Acero inoxidable		Alberca		Aspersores		Batería recargable
	Clavija		Contacto aterrizado		Contacto polarizado		Fácil instalación
	Fácil instalación		Factor de protección		Garantía: 1 año		Garantía: 2 años
	Garantía: 3 años		Garantía: 10 años		Incluye tornillos		Índice de protección
	Índice de reproducción cromática		LED		Luz dimerizable		No incluye baterías
	Norma Oficial Mexicana		No requiere cableado		Omnidireccional		Panel solar
	Policarbonato		Salida USB		Sensor de movimiento		Tinoco
	Tiempo de vida		Tipo de base: E26/E27		Tipo de base: GU10		Tipo de base: MR16
	Tipo de empaque: - Blister		Tipo de empaque: - Bolsa		Uso agrícola		Uso doméstico
	Voltaje						

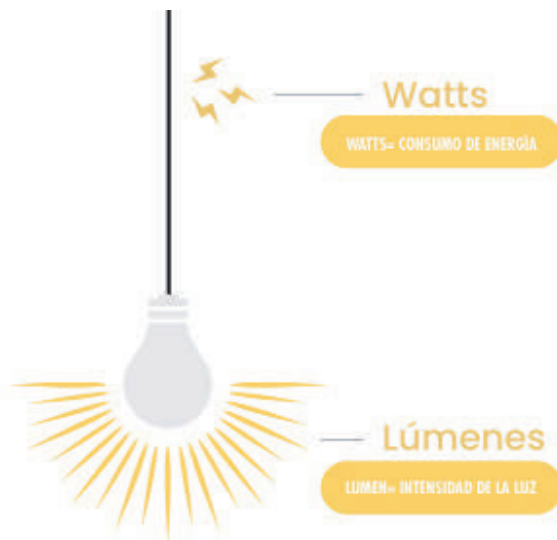

WATTS (CONSUMO DE ENERGÍA)	LÚMENES (INTENSIDAD DE LA LUZ)
Foco tradicional (10lm/Watt)	Foco LED (100lm/Watt)
40 W 0-450 Lúmenes	2-5 W 0-450 Lúmenes
60 W 500-850 Lúmenes	6-9 W 500-850 Lúmenes
75 W 900-1150 Lúmenes	11-14 W 900-1150 Lúmenes
100 W 1200-1650 Lúmenes	15-17 W 1200-1650 Lúmenes

Los focos LED utilizan significativamente menos energía (watts) para emitir la misma intensidad de luz (lúmenes) que cualquier foco tradicional incandescente.



PRIMER DÍGITO (PROTECCIÓN CONTRA SÓLIDOS)	DEFINICIÓN	SEGUNDO DÍGITO (PROTECCIÓN CONTRA LÍQUIDOS)	DEFINICIÓN
0	Sin protección	0	Sin protección
1	Protegido contra objetos sólidos de más de 50 mm (contactos involuntarios con las manos)	1	Protegido contra caídas verticales de gotas de agua o condensación
2	Protegido contra objetos sólidos de más de 12 mm (contacto con los dedos)	2	Protegido contra caídas verticales de gotas de agua con una inclinación de 15° respecto a la vertical
3	Protegido contra objetos sólidos de más de 2.5 mm (herramientas y cables)	3	Protegido contra salpicaduras de gotas de agua con una inclinación de 60° respecto a la vertical
4	Protegido contra objetos sólidos de más de 1 mm (herramientas y pequeños cables)	4	Protegido contra salpicaduras de gotas en todas direcciones, el ingreso de cantidades limitadas de agua es permitido
5	Protegido contra ingreso limitado de polvo. (no incluye materiales peligrosos)	5	Protegido contra chorros de agua de baja presión, el ingreso limitado de agua es permitido
6	Totalmente protegido contra polvo. Totalmente sellado.	6	Protegido contra potentes chorros de agua
		7	Protegido contra efectos de inmersión temporal
		8	Equipo adecuado para inmersión prolongada bajo las especificaciones de fabricante

¿Qué son las normas NOM?

Las normas mexicanas contienen la información, requisitos, especificaciones y metodologías que deben cumplir los productos o servicios para su comercialización en el país, de acuerdo con sus campos de acción. Su objetivo es adoptar estándares de calidad nacional.



Cumple con las NOM que dicta la ley.



PRECAUCIÓN

NO EXCEDER EL VOLTAJE
NI AMPERAJE RECOMENDADO

NUEVOS PRODUCTOS



NUEVO

SMARTHOME PLACAS



SH1101 - SH1201

Apagador Touch Smart de 1 módulo



11.6 x 7 x 4.5 cm



Apagador 110-240 V- /10 A

○ SH1101 ● SH1201

MULTIVOLTAJE
PROTEGE TUS APARATOS

Inner: Master 10 60

Polycarbonato
 Touch
 Control por voz
 Aplicación móvil

Colores disponibles:
○ Blanco ● Negro

SH1102 - SH1202

Apagador Touch Smart de 2 módulos



11.6 x 7 x 4.5 cm



Apagador 110-240 V- /10 A

○ SH1102 ● SH1202

MULTIVOLTAJE
PROTEGE TUS APARATOS

Inner: Master 10 60

Polycarbonato
 Touch
 Control por voz
 Aplicación móvil

Colores disponibles:
○ Blanco ● Negro

SH1103 - SH1203

Apagador Touch Smart de 3 módulos



11.6 x 7 x 4.5 cm



Apagador 110-240 V- /10 A

○ SH1103 ● SH1203

MULTIVOLTAJE
PROTEGE TUS APARATOS

Inner: Master 10 60

Polycarbonato
 Touch
 Control por voz
 Aplicación móvil

Colores disponibles:
○ Blanco ● Negro

SH1104 - SH1204

Placa dúplex Smart + 2 USB



11.6 x 7 x 4.5 cm



USB 5 V= 3 A

Apagador 125-250 V- /15 A

○ SH1104 ● SH1204

MULTIVOLTAJE
PROTEGE TUS APARATOS

Inner: Master 10 60

Polycarbonato
 Control por voz
 Aplicación móvil
 Conexión USB

Colores disponibles:
○ Blanco ● Negro

Lámpara LED
A19 Wi-Fi

Consumo
10 W

Flujo
900 lm

Inner 10
Master 100

Altura
12 cm

MULTIVOLTAJE
PROTEGE TUS APARATOS

Modelo Luz
SH2001 Multicolor



TECNOLOGÍA
Wi-Fi

TECNOLOGÍA
BLUETOOTH

- 100-240 V-
- E27
- 20 000 h
- DIRECCIONAL 200°

Reemplaza	Frecuencia	Tipo de bulbo	Intensidad de corriente
60 W	60 Hz	E27	140 mA

CREA EL AMBIENTE
PERFECTO



REGULABLE CALIDO Y BLANCO

16 MILLONES DE COLORES
A TU ELECCIÓN



16 MILLONES DE COLORES OPCIONALES



Lámpara LED
Dicroico GU5.3

Consumo
5 W

Flujo
400 lm

Inner 10
Master 100

Altura
6 cm

MULTIVOLTAJE
PROTEGE TUS APARATOS

Modelo Luz
SH2003 Multicolor



TECNOLOGÍA
Wi-Fi

TECNOLOGÍA
BLUETOOTH

- 100-240 V-
- GU5.3
- 20 000 h
- DIRECCIONAL 100°

Reemplaza	Frecuencia	Tipo de bulbo	Intensidad de corriente
40 W	60 Hz	MR 16	80 mA

Lámpara LED
Dicroico GU10

Consumo
5 W

Flujo
400 lm

Inner 10
Master 100

Altura
6 cm

MULTIVOLTAJE
PROTEGE TUS APARATOS

Modelo Luz
SH2004 Multicolor



TECNOLOGÍA
Wi-Fi

TECNOLOGÍA
BLUETOOTH

- 100-240 V-
- GU10
- 20 000 h
- DIRECCIONAL 100°

Reemplaza	Frecuencia	Tipo de bulbo	Intensidad de corriente
40 W	60 Hz	GU10	80 mA

* Las imágenes mostradas en este catálogo son con fines ilustrativos. IGOTO® se reserva el derecho de modificar la información sin previo aviso y no se hace responsable por omisiones o errores en este documento.



NUEVO

SMARTHOME ARTEFACTOS



SH3001 Contacto sencillo



NOM



Contacto 125 V- /15 A

Polycarbonato

Inner 10 | Master 150

Fácil instalación



Polycarbonato
Tecnología Wi-Fi
Control por voz
Conexión Bluetooth

Colores disponibles:
○ Blanco

SH3002 Contacto dúplex



NOM



Contacto 125 V- /15 A

Polycarbonato

Inner 10 | Master 140

Fácil instalación



Polycarbonato
Tecnología Wi-Fi
Control por voz
Conexión Bluetooth

Colores disponibles:
○ Blanco

MULTIVOLTAJE
PROTEGE TUS APARATOS

SH3003 Contacto + USB + USBC



NOM



Contacto 125 V- /15 A

USB 5 V=, 2,1 A

Polycarbonato

Inner 10 | Master 140

Fácil instalación



Polycarbonato
Tecnología Wi-Fi
Control por voz
Conexión Bluetooth

Colores disponibles:
○ Blanco

MULTIVOLTAJE
PROTEGE TUS APARATOS



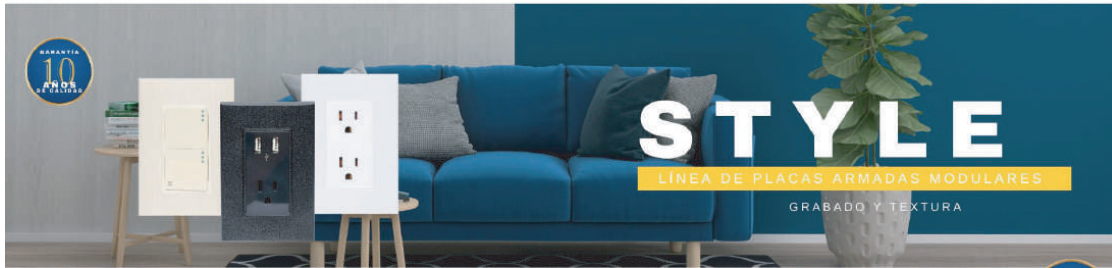

INOX1001 - INOX2001
Placa con contacto dúplex



NOM

8.5 x 1.2 cm



Placa

Mecanismo

Contacto 125-250 V~/15 A

● INOX1001 ● INOX2001

MULTIVOLTAJE
PROTEGE TUS APARATOS

Inner: Master 10 100 Incluye Bolsa Acero inoxidable Polycarbonato Colores disponibles: ● Plata ● Oxford

INOX1002 - INOX2002
Placa con apagador sencillo y contacto de 1.5 módulos



NOM

8.5 x 1.2 cm



Placa

Mecanismo

Apagador 125-250 V~/10 A

Contacto 125-250 V~/15 A

● INOX1002 ● INOX2002

MULTIVOLTAJE
PROTEGE TUS APARATOS

Inner: Master 10 100 Incluye Bolsa Acero inoxidable Polycarbonato Colores disponibles: ● Plata ● Oxford

* Las imágenes mostradas en este catálogo son con fines ilustrativos. IGOTO® se reserva el derecho de modificar la información sin previo aviso y no se hace responsable por omisiones o errores en este documento.



INOX1003 - INOX2003

Placa con 1 apagador sencillo y 2 contactos de un módulo



NOM

8.5 x 12 cm



Placa

Mecanismo

Apagador 125-250 V~/10 A

Contacto 125-250 V~/15 A

● INOX1003 ● INOX2003

MULTIVOLTAJE
PROTEGE TUS APARATOS

Inner: Master Incluye Bolsa Acero inoxidable Colores disponibles:
10 100 Policarbonato ● Plata ● Oxford

INOX1004 - INOX2004

Placa con 3 contactos de un módulo



NOM

8.5 x 12 cm



Placa

Mecanismo

Contacto 125-250 V~/15 A

● INOX1004 ● INOX2004

MULTIVOLTAJE
PROTEGE TUS APARATOS

Inner: Master Incluye Bolsa Acero inoxidable Colores disponibles:
10 100 Policarbonato ● Plata ● Oxford

INOX1005 - INOX2005

Placa con 1 apagador sencillo de 3 módulos



NOM

8.5 x 12 cm



Placa

Mecanismo

Apagador 125-250 V~/10 A

● INOX1005 ● INOX2005

MULTIVOLTAJE
PROTEGE TUS APARATOS

Inner: Master Incluye Bolsa Acero inoxidable Colores disponibles:
10 100 Policarbonato ● Plata ● Oxford

INOX1006 - INOX2006

Placa con 2 tomas USB y 1 contacto



NOM

8.5 x 12 cm



Placa

Mecanismo

In Put 110-250 V~

Out Put 5 V~-2.1 A

Contacto 125-250 V~/15 A

● INOX1006 ● INOX2006

MULTIVOLTAJE
PROTEGE TUS APARATOS

Inner: Master Incluye Bolsa Acero inoxidable Colores disponibles:
8 80 Policarbonato ● Plata ● Oxford

INOX1007 - INOX2007

Placa con 1 apagador escalera y 1 contacto de 1.5 módulos



NOM

8.5 x 12 cm



Placa

Mecanismo

Apagador 125-250 V~/10 A

Contacto 125-250 V~/15 A

● INOX1007 ● INOX2007

MULTIVOLTAJE
PROTEGE TUS APARATOS

Inner: Master Incluye Bolsa Acero inoxidable Colores disponibles:
10 100 Policarbonato ● Plata ● Oxford

INOX1008 - INOX2008

Placa con 1 apagador escalera de 3 módulos



NOM

8.5 x 12 cm



Placa

Mecanismo

Apagador 125-250 V~/10 A

● INOX1008 ● INOX2008

MULTIVOLTAJE
PROTEGE TUS APARATOS

Inner: Master Incluye Bolsa Acero inoxidable Colores disponibles:
10 100 Policarbonato ● Plata ● Oxford



INOX1009 - INOX2009

Placa con 2 apagadores sencillos y 1 contacto de un módulo



NOM

8.5 x 12 cm



Placa 

Mecanismo 

Apagador 125-250 V~/10 A

Contacto 125-250 V~/15 A

● INOX1009

● INOX2009

MULTIVOLTAJE
PROTEGE TUS APARATOS

Inner: Master Incluye Bolsa  Acero inoxidable Colores disponibles:
10 100   Policarbonato ● Plata ● Oxford

INOX1010 - INOX2010

Placa con 2 apagadores sencillos de 1.5 módulos



NOM

8.5 x 12 cm



Placa 

Mecanismo 

Apagador 125-250 V~/10 A

● INOX1010

● INOX2010

MULTIVOLTAJE
PROTEGE TUS APARATOS

Inner: Master Incluye Bolsa  Acero inoxidable Colores disponibles:
10 100   Policarbonato ● Plata ● Oxford

INOX1011 - INOX2011

Placa con toma coaxial salida T.V.



NOM

8.5 x 12 cm



Placa 

Mecanismo 

● INOX1011

● INOX2011

Inner: Master Incluye Bolsa  Acero inoxidable Colores disponibles:
10 100   Policarbonato ● Plata ● Oxford

INOX1012 - INOX2012

Placa con 1 apagador sencillo y 1 apagador escalera de 1.5 módulos



NOM

8.5 x 12 cm



Placa 

Mecanismo 

Apagador 125-250 V~/10 A

● INOX1012

● INOX2012

MULTIVOLTAJE
PROTEGE TUS APARATOS

Inner: Master Incluye Bolsa  Acero inoxidable Colores disponibles:
10 100   Policarbonato ● Plata ● Oxford

INOX1013 - INOX2013

Placa con 3 apagadores sencillos de un módulo



NOM

8.5 x 12 cm



Placa 

Mecanismo 

Contacto 125-250 V~/15 A

● INOX1013

● INOX2013

MULTIVOLTAJE
PROTEGE TUS APARATOS

Inner: Master Incluye Bolsa  Acero inoxidable Colores disponibles:
10 100   Policarbonato ● Plata ● Oxford

INOX1014 - INOX2014

Placa con 2 apagadores escalera de 1.5 módulos



NOM

8.5 x 12 cm



Placa 

Mecanismo 

Apagador 125-250 V~/10 A

● INOX1014

● INOX2014

MULTIVOLTAJE
PROTEGE TUS APARATOS

Inner: Master Incluye Bolsa  Acero inoxidable Colores disponibles:
10 100   Policarbonato ● Plata ● Oxford

* Las imágenes mostradas en este catálogo son con fines ilustrativos. IGOTO® se reserva el derecho de modificar la información sin previo aviso y no se hace responsable por omisiones o errores en este documento.



INOX1015 - INOX2015

Placa ciega



NOM

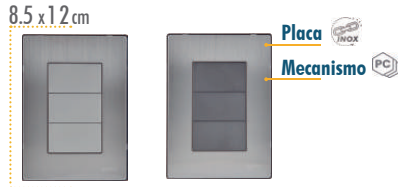

● INOX1015 ● INOX2015

Inner: Master Incluye Bolsa Acero inoxidable Colores disponibles:
10 100 Policarbonato ● Plata ● Oxford

INOX1016 - INOX2016

Placa con 2 apagadores sencillos y 1 apagador escalera de un módulo



NOM



● INOX1016 ● INOX2016

MULTIVOLTAJE
PROTEGE TUS APARATOS

Inner: Master Incluye Bolsa Acero inoxidable Colores disponibles:
10 100 Policarbonato ● Plata ● Oxford

INOX1017 - INOX2017

Placa con toma telefónica



NOM



● INOX1017 ● INOX2017

Inner: Master Incluye Bolsa Acero inoxidable Colores disponibles:
10 100 Policarbonato ● Plata ● Oxford

INOX1018 - INOX2018

Placa con 1 botón de timbre



NOM

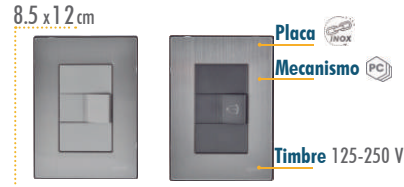

● INOX1018 ● INOX2018

MULTIVOLTAJE
PROTEGE TUS APARATOS

Inner: Master Incluye Bolsa Acero inoxidable Colores disponibles:
10 100 Policarbonato ● Plata ● Oxford

INOX1019 - INOX2019

Placa con dimmer



NOM



● INOX1019 ● INOX2019

Inner: Master Incluye Bolsa Acero inoxidable Colores disponibles:
8 80 Policarbonato ● Plata ● Oxford

INOX1020 - INOX2020

Placa con 1 toma telefónica y 1 toma coaxial salida T.V.



NOM

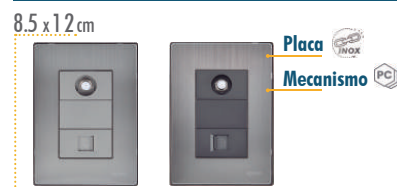

● INOX1020 ● INOX2020

Inner: Master Incluye Bolsa Acero inoxidable Colores disponibles:
10 100 Policarbonato ● Plata ● Oxford



INOX1021 - INOX2021

Placa con 3 apagadores escalera de un módulo



8.5 x 1.2 cm



● INOX1021 ● INOX2021

MULTIVOLTAJE
PROTEGE TUS APARATOS

Inner: 10 Master: 100 Incluye: Bolsa: Acero inoxidable Colores disponibles: Plata Oxford Policarbonato

INOX1022 - INOX2022

Placa toma datos



8.5 x 1.2 cm

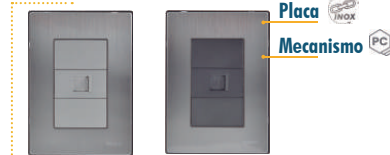

● INOX1022 ● INOX2022

Inner: 10 Master: 100 Incluye: Bolsa: Acero inoxidable Colores disponibles: Plata Oxford Policarbonato

INOX1023 - INOX2023

Placa con timbre zumbador



8.5 x 1.2 cm



● INOX1023 ● INOX2023

MULTIVOLTAJE
PROTEGE TUS APARATOS

Inner: 8 Master: 80 Incluye: Bolsa: Acero inoxidable Colores disponibles: Plata Oxford Policarbonato

INOX1024 - INOX2024

Placa con contacto dúplex falla tierra



8.5 x 1.2 cm



● INOX1024 ● INOX2024

MULTIVOLTAJE
PROTEGE TUS APARATOS

Inner: 6 Master: 60 Incluye: Bolsa: Acero inoxidable Colores disponibles: Plata Oxford Policarbonato

NUEVO

INOX1025 - INOX2025 Placa con contacto dúplex + USB + USB-C



8.5 x 1.2 cm



● INOX1025 ● INOX2025

MULTIVOLTAJE
PROTEGE TUS APARATOS

Inner: 8 Master: 80 Incluye: Bolsa: Acero inoxidable Colores disponibles: Plata Oxford Policarbonato

* Las imágenes mostradas en este catálogo son con fines ilustrativos. IGOTO® se reserva el derecho de modificar la información sin previo aviso y no se hace responsable por omisiones o errores en este documento.





PB511 Placa con 1 apagador sencillo de 3 módulos

8x12cm



○ PB511-B



○ PB511-M



● PB511-N

Apagador 125-250 V~/10 A

Policarbonato

MULTIVOLTAJE
PROTEGE TUS APARATOS



NOM

Inner 10 | Master 100 | Fácil instalación  | Bolsa  | Incluye  | Colores disponibles: ○ Blanco ○ Marfil ● Negro

PB512 Placa con 1 apagador escalera de 3 módulos

8x12cm



○ PB512-B



○ PB512-M



● PB512-N

Apagador 125-250 V~/10 A

Policarbonato

MULTIVOLTAJE
PROTEGE TUS APARATOS



NOM

Inner 10 | Master 100 | Fácil instalación  | Bolsa  | Incluye  | Colores disponibles: ○ Blanco ○ Marfil ● Negro

PB513 Placa con 2 apagadores sencillos de 1.5 módulos

8x12cm



○ PB513-B



○ PB513-M



● PB513-N

Apagador 125-250 V~/10 A

Policarbonato

MULTIVOLTAJE
PROTEGE TUS APARATOS



NOM

Inner 10 | Master 100 | Fácil instalación  | Bolsa  | Incluye  | Colores disponibles: ○ Blanco ○ Marfil ● Negro



PB515 Placa con 3 apagadores sencillos de un módulo

8x12cm



○ PB515-B



○ PB515-M



● PB515-N

Apagador 125-250 V~/10 A

Policarbonato

MULTIVOLTAJE
PROTEGE TUS APARATOS



Inner 10 | **Master** 100 | **Fácil instalación** | **Bolsa** | **Incluye** | **Colores disponibles:** ○ Blanco ○ Marfil ● Negro

PB612 Placa con apagador sencillo y contacto 2P+T de 1.5 módulos

8x12cm



○ PB612-B



○ PB612-M



● PB612-N

Contacto 125-250 V~/15 A

Apagador 125-250 V~/10 A

Policarbonato

MULTIVOLTAJE
PROTEGE TUS APARATOS



Inner 10 | **Master** 100 | **Fácil instalación** | **Bolsa** | **Incluye** | **Colores disponibles:** ○ Blanco ○ Marfil ● Negro

PB613 Placa con apagador sencillo y apagador escalera de 1.5 módulos

8x12cm



○ PB613-B



○ PB613-M



● PB613-N

Apagador 125-250 V~/10 A

Policarbonato

MULTIVOLTAJE
PROTEGE TUS APARATOS



Inner 10 | **Master** 100 | **Fácil instalación** | **Bolsa** | **Incluye** | **Colores disponibles:** ○ Blanco ○ Marfil ● Negro

* Las imágenes mostradas en este catálogo son con fines ilustrativos. IGOTO® se reserva el derecho de modificar la información sin previo aviso y no se hace responsable por omisiones o errores en este documento.



PB615 Placa con 2 apagadores sencillos y apagador escalera de 1 módulo

8x12cm



○ PB615-B



○ PB615-M



● PB615-N

Apagador 125-250 V~/10 A

Policarbonato

MULTIVOLTAJE
PROTEGE TUS APARATOS



Inner 10 **Master** 100 **Fácil instalación**  **Bolsa**  **Incluye**  **Colores disponibles:** ○ Blanco ○ Marfil ● Negro

PB414 Placa con 1 apagador sencillo y 2 contactos 2P+T

8x12cm



○ PB414-B



○ PB414-M



● PB414-N

Apagador 125-250 V~/10 A

Contacto 125-250 V~/15 A

Policarbonato

MULTIVOLTAJE
PROTEGE TUS APARATOS



Inner 10 **Master** 100 **Fácil instalación**  **Bolsa**  **Incluye**  **Colores disponibles:** ○ Blanco ○ Marfil ● Negro

PB412 Placa con 2 apagadores sencillo y 1 contacto 2P+T

8x12cm



○ PB412-B



○ PB412-M



● PB412-N

Apagador 125-250 V~/10 A

Contacto 125-250 V~/15 A

Policarbonato

MULTIVOLTAJE
PROTEGE TUS APARATOS



Inner 10 **Master** 100 **Fácil instalación**  **Bolsa**  **Incluye**  **Colores disponibles:** ○ Blanco ○ Marfil ● Negro

PB105/3 Placa con 3 contactos 2P+T de un módulo



8x12cm



Contacto 125-250 V~/15 A

Policarbonato

PB105/3-B

PB105/3-M

PB105/3-N

MULTIVOLTAJE
PROTEGE TUS APARATOS

Inner 10 | **Master** 100 | **Fácil instalación** | **Bolsa** | **Incluye** | **Colores disponibles:** Blanco Marfil Negro

PBUSB2 Placa con 2 USB y 2 contactos de un módulo



8x12cm



Contacto 125-250 V~/15 A

USB **In Put** 110-250 V~ | **Out Put** 5 V~-2.1 A | **Frecuencia** 50/60 Hz

Policarbonato

PBUSB2-B

PBUSB2-M

PBUSB2-N

MULTIVOLTAJE
PROTEGE TUS APARATOS

Inner 8 | **Master** 80 | **Fácil instalación** | **Bolsa** | **Incluye** | **Colores disponibles:** Blanco Marfil Negro

PBUSB4 Placa con 4 USB y 1 contacto de un módulo



8x12cm



Contacto 125-250 V~/15 A

USB **In Put** 110-250 V~ | **Out Put** 5 V~-2.1 A | **Frecuencia** 50/60 Hz

Policarbonato

PBUSB4-B

PBUSB4-M

PBUSB4-N

MULTIVOLTAJE
PROTEGE TUS APARATOS

Inner 8 | **Master** 80 | **Fácil instalación** | **Bolsa** | **Incluye** | **Colores disponibles:** Blanco Marfil Negro

* Las imágenes mostradas en este catálogo son con fines ilustrativos. IGOITO® se reserva el derecho de modificar la información sin previo aviso y no se hace responsable por omisiones o errores en este documento.





PB106UL Placa con contacto USB doble

8x12 cm



PB106UL-B



PB106UL-M



PB106UL-N

In Put 110-250 V~ **Out Put** 5 V~-2.1 A **Frecuencia** 50/60 Hz

Contacto 125-250 V~/15 A

Policarbonato

MULTIVOLTAJE
PROTEGE TUS APARATOS



NOM

Inner
8

Master
80



Colores disponibles:

Blanco Marfil Negro

PB519 Placa con botón timbre

8x12 cm



PB519-B



PB519-M



PB519-N

125-250 V~

Policarbonato

MULTIVOLTAJE
PROTEGE TUS APARATOS



NOM

Inner
10

Master
100



Colores disponibles:

Blanco Marfil Negro

PB402 Placa con toma de teléfono

8x12 cm



PB402-B



PB402-M



PB402-N

Policarbonato

MULTIVOLTAJE
PROTEGE TUS APARATOS



NOM

Inner
10

Master
100



Colores disponibles:

Blanco Marfil Negro



PB302 Placa con toma coaxial TV



NOM

8x12 cm



○ PB302-B



○ PB302-M



● PB302-N

Policarbonato

Inner 10 | **Master** 100 | **Fácil instalación** | **Bolsa** | **Incluye** | **Colores disponibles:** ○ Blanco ○ Marfil ● Negro

PB201 Placa con dimmer



NOM

8x12 cm



○ PB201-B



○ PB201-M



● PB201-N

200 W

Policarbonato

Inner 6 | **Master** 60 | **Fácil instalación** | **Bolsa** | **Incluye** | **Colores disponibles:** ○ Blanco ○ Marfil ● Negro

PB105/2 Contacto dúplex con placa



NOM

8x12 cm



○ PB105/2-B



○ PB105/2-M



● PB105/2-N

Contacto 125-250 V~/15 A

Policarbonato

MULTIVOLTAJE
PROTEGE TUS APARATOS

Inner 10 | **Master** 100 | **Fácil instalación** | **Bolsa** | **Incluye** | **Colores disponibles:** ○ Blanco ○ Marfil ● Negro

* Las imágenes mostradas en este catálogo son con fines ilustrativos. IGOTO® se reserva el derecho de modificar la información sin previo aviso y no se hace responsable por omisiones o errores en este documento.





NUEVO

PB105/USBC Contacto dúplex +USB y USBC



NOM

8x12cm



PB105/USB-B



PB105/USB-M



PB105/USB-N

Contacto 125-250 V~/15 A

USB

In Put 110-250 V~

Out Put 5 V~ 3 A

Frecuencia 50/60 Hz

Policarbonato

MULTIVOLTAJE
PROTEGE TUS APARATOS

Inner
8

Master
80

Fácil instalación

Bolsa

Incluye

Colores disponibles:
 Blanco Marfil Negro

PB801 Contacto dúplex falla tierra con placa



NOM

8x12cm



PB801-B



PB801-M



PB801-B

Contacto 125-250 V~/15 A

Policarbonato

MULTIVOLTAJE
PROTEGE TUS APARATOS

Inner
6

Master
60

Fácil instalación

Bolsa

Incluye

Colores disponibles:
 Blanco Marfil Negro

PB105/2 Contacto dúplex con placa



NOM

8x12cm



PB105/2-A/B



PB105/2-A/N



PB105/2-B/N



PB105/2-N/B

Contacto 125-250 V~/15 A

Policarbonato

MULTIVOLTAJE
PROTEGE TUS APARATOS

Inner
10

Master
100

Fácil instalación

Bolsa

Incluye

Colores disponibles:
 Plata-Blanco Plata-Negro
 Negro-Blanco Blanco-Negro

PB105/2-D Contacto dúplex con placa



8x12cm



Contacto 125-250 V~/15 A

Policarbonato

● PB105/2-D/B

● PB105/2-D/M

● PB105/2-D/N

MULTIVOLTAJE
PROTEGE TUS APARATOS

Inner 10	Master 100	Fácil instalación 	Bolsa 	Incluye 	Colores disponibles: ● Dorado-Blanco ● Dorado-Marfil ● Dorado-Negro
--------------------	----------------------	------------------------------	------------------	--------------------	--

PB105/2-MC Contacto dúplex con placa



8x12cm



Contacto 125-250 V~/15 A

Policarbonato

● PB105/2-MC/B

● PB105/2-MC/M

● PB105/2-MC/N

MULTIVOLTAJE
PROTEGE TUS APARATOS

Inner 10	Master 100	Fácil instalación 	Bolsa 	Incluye 	Colores disponibles: ● Caoba-Blanco ● Caoba-Marfil ● Caoba-Negro
--------------------	----------------------	------------------------------	------------------	--------------------	---

PB105/2-MW Contacto dúplex con placa



8x12cm



Contacto 125-250 V~/15 A

Policarbonato

● PB105/2-MW/B

● PB105/2-MW/M

● PB105/2-MW/N

MULTIVOLTAJE
PROTEGE TUS APARATOS

Inner 10	Master 100	Fácil instalación 	Bolsa 	Incluye 	Colores disponibles: ● Wenge-Blanco ● Wenge-Marfil ● Wenge-Negro
--------------------	----------------------	------------------------------	------------------	--------------------	---

* Las imágenes mostradas en este catálogo son con fines ilustrativos. IGOTO® se reserva el derecho de modificar la información sin previo aviso y no se hace responsable por omisiones o errores en este documento.



PB1201 Placa con 1 módulo



8x12 cm



○ PB1201-B ○ PB1201-M ○ PB1201-PE ○ PB1201-D ○ PB1201-P ○ PB1201-GR ○ PB1201-N ○ PB1201-MW ○ PB1201-MC

Inner
20

Master
200



Colores disponibles:

○ Blanco ○ Marfil ○ Perla ○ Dorado ○ Plata ○ Grafito
● Negro ● Wenge ● Caoba

PB1202 Placa con 2 módulos



8x12 cm



○ PB1202-B ○ PB1202-M ○ PB1202-PE ○ PB1202-D ○ PB1202-P ○ PB1202-GR ○ PB1202-N ○ PB1202-MW ○ PB1202-MC

Inner
20

Master
200



Colores disponibles:

○ Blanco ○ Marfil ○ Perla ○ Dorado ○ Plata ○ Grafito
● Negro ● Wenge ● Caoba

PB1203 Placa con 3 módulos



8x12 cm



○ PB1203-B ○ PB1203-M ○ PB1203-PE ○ PB1203-D ○ PB1203-P ○ PB1203-GR ○ PB1203-N ○ PB1203-MW ○ PB1203-MC

Inner
20

Master
200



Colores disponibles:

○ Blanco ○ Marfil ○ Perla ○ Dorado ○ Plata ○ Grafito
● Negro ● Wenge ● Caoba



➤ **LÍNEA ARMADA LUGANO PLUS**

LÍNEA DE PLACAS: LP LUGANO PLUS SP STYLE PLUS ZP ZURICH PLUS

PB1200 Placa ciega



8x12 cm



○ PB1200-B ○ PB1200-M ○ PB1200-PE ○ PB1200-D ○ PB1200-P ○ PB1200-GR ○ PB1200-N ○ PB1200-MW ○ PB1200-MC

Inner 20

Master 200



Colores disponibles:

○ Blanco ○ Marfil ○ Perla ○ Dorado ○ Plata ○ Grafito
● Negro ● Wenge ● Caoba

LÍNEA DE PLACAS: LP LUGANO PLUS SP STYLE PLUS ZP ZURICH PLUS

LÍNEA ARMADA STYLE PLUS



PS511 Placa con 1 apagador sencillo de 3 módulos



NOM

8x12 cm



○ PS511-B ○ PS511-M ○ PS511-PE ○ PS511-GR

MULTIVOLTAJE
PROTEGE TUS APARATOS

Inner 10

Master 100



Colores disponibles:

○ Blanco ○ Marfil ○ Perla ○ Grafito

PS512 Placa con 1 apagador escalera de 3 módulos



NOM

8x12 cm



○ PS512-B ○ PS512-M ○ PS512-PE ○ PS512-GR

MULTIVOLTAJE
PROTEGE TUS APARATOS

Inner 10

Master 100



Colores disponibles:

○ Blanco ○ Marfil ○ Perla ○ Grafito

* Las imágenes mostradas en este catálogo son con fines ilustrativos. IGOTO® se reserva el derecho de modificar la información sin previo aviso y no se hace responsable por omisiones o errores en este documento.



PS513 Placa con 2 apagadores sencillos de 1.5 módulos

8x12 cm



- PS513-B PS513-M PS513-PE PS513-GR

MULTIVOLTAJE
PROTEGE TUS APARATOS



Inner 10 **Master** 100 **Fácil instalación**  **Bolsa**  **Incluye**  **Colores disponibles:** Blanco Marfil Perla Grafito

PS515 Placa con 3 apagadores sencillos de 1 módulo

8x12 cm



- PS515-B PS515-M PS515-PE PS515-GR

MULTIVOLTAJE
PROTEGE TUS APARATOS



Inner 10 **Master** 100 **Fácil instalación**  **Bolsa**  **Incluye**  **Colores disponibles:** Blanco Marfil Perla Grafito

PS612 Placa con apagador sencillo y contacto 2P+T de 1.5 módulos

8x12 cm



- PS612-B PS612-M PS612-PE PS612-GR

MULTIVOLTAJE
PROTEGE TUS APARATOS



Inner 10 **Master** 100 **Fácil instalación**  **Bolsa**  **Incluye**  **Colores disponibles:** Blanco Marfil Perla Grafito

PS613 Placa con 2 apagador sencillo y apagador escalera de 1.5 módulos

8x12 cm



- PS613-B ○ PS613-M ○ PS613-PE ● PS613-GR

MULTIVOLTAJE
PROTEGE TUS APARATOS



Inner 10 **Master** 100 **Fácil instalación** **Bolsa** **Incluye** **Colores disponibles:**
○ Blanco ○ Marfil ○ Perla ● Grafito

PS615 Placa con 2 apagadores sencillos y uno de escalera de un modulo

8x12 cm



- PS615-B ○ PS615-M ○ PS615-PE ● PS615-GR

MULTIVOLTAJE
PROTEGE TUS APARATOS



Inner 10 **Master** 100 **Fácil instalación** **Bolsa** **Incluye** **Colores disponibles:**
○ Blanco ○ Marfil ○ Perla ● Grafito

PS412 Placa con 2 apagadores sencillos y contacto 2+ T de un módulo

8x12 cm



- PS412-B ○ PS412-M ○ PS412-PE ● PS412-GR

MULTIVOLTAJE
PROTEGE TUS APARATOS



Inner 10 **Master** 100 **Fácil instalación** **Bolsa** **Incluye** **Colores disponibles:**
○ Blanco ○ Marfil ○ Perla ● Grafito

* Las imágenes mostradas en este catálogo son con fines ilustrativos.
IGOTO® se reserva el derecho de modificar la información sin previo aviso y no se hace responsable por omisiones o errores en este documento.



PS414 Placa con 1 apagador sencillo y 2 contactos 2PT+T de un módulo



8x12 cm



Apagador 125-250 V~/10 A
 Contacto 125-250 V~/15 A
 Policarbonato

- PS414-B
- PS414-M
- PS414-PE
- PS414-GR

MULTIVOLTAJE
 PROTEGE TUS APARATOS

Inner 10 **Master** 100 **Fácil instalación**  **Bolsa**  **Incluye**  **Colores disponibles:**
 Blanco Marfil Perla Grafito

PS105/2 Contacto dúplex con placa



8x12 cm



Contacto 125-250 V~/15 A
 Policarbonato

- PS105/2-B
- PS105/2-M
- PS105/2-PE
- PS105/2-GR

MULTIVOLTAJE
 PROTEGE TUS APARATOS

Inner 10 **Master** 100 **Fácil instalación**  **Bolsa**  **Incluye**  **Colores disponibles:**
 Blanco Marfil Perla Grafito

PS105/3 Placa con 3 contactos 2P+T de un módulo



8x12 cm



Contacto 125-250 V~/15 A
 Policarbonato

- PS105/3-B
- PS105/3-M
- PS105/3-PE
- PS105/3-GR

MULTIVOLTAJE
 PROTEGE TUS APARATOS

Inner 10 **Master** 100 **Fácil instalación**  **Bolsa**  **Incluye**  **Colores disponibles:**
 Blanco Marfil Perla Grafito

PS519 Placa con botón timbre



8x12cm



125-250 V~

Policarbonato

- PS519-B
- PS519-M
- PS519-PE
- PS519-GR

MULTIVOLTAJE
PROTEGE TUS APARATOS

Inner 10 **Master** 100 **Fácil instalación** **Bolsa** **Incluye** **Colores disponibles:**
 Blanco Marfil Perla Grafito

PS801 Contacto dúplex con placa falla tierra



8x12cm



Contacto 125-250 V~/15 A

Policarbonato

- PS801-B
- PS801-M
- PS801-PE
- PS801-GR

MULTIVOLTAJE
PROTEGE TUS APARATOS

Inner 6 **Master** 60 **Fácil instalación** **Bolsa** **Incluye** **Colores disponibles:**
 Blanco Marfil Perla Grafito

PSUSB2 Placa con 2 USB y 2 contactos de un módulo



8x12cm



USB

In Put 110-250 V~ Out Put 5 V~-2.1 A Frecuencia 50/60 Hz

Contacto 125-250 V~/15 A

Policarbonato

- PSUSB2-B
- PSUSB2-M
- PSUSB2-PE
- PSUSB2-GR

MULTIVOLTAJE
PROTEGE TUS APARATOS

Inner 8 **Master** 80 **Fácil instalación** **Bolsa** **Incluye** **Colores disponibles:**
 Blanco Marfil Perla Grafito

* Las imágenes mostradas en este catálogo son con fines ilustrativos. IGOTO® se reserva el derecho de modificar la información sin previo aviso y no se hace responsable por omisiones o errores en este documento.





PSUSB4 Placa con 4 USB y 1 contacto de un módulo

8x12 cm



- PSUSB4-B PSUSB4-M PSUSB4-PE PSUSB4-GR

USB
Contacto
Policarbonato

In Put 110-250 V~
Out Put 5 V~-2.1 A
Frecuencia 50/60 Hz

125-250 V~/15 A

MULTIVOLTAJE
PROTEGE TUS APARATOS

Inner 8 **Master** 80 **Fácil instalación** **Bolsa** **Incluye** **Colores disponibles:**
 Blanco Marfil Perla Grafito

PS106UL Placa con contacto USB doble

8x12 cm



- PS106UL-B PS106UL-M PS106UL-PE PS106UL-GR

USB
Contacto
Policarbonato

In Put 110-250 V~
Out Put 5 V~-2.1 A
Frecuencia 50/60 Hz

125-250 V~/15 A

MULTIVOLTAJE
PROTEGE TUS APARATOS

Inner 8 **Master** 80 **Fácil instalación** **Bolsa** **Incluye** **Colores disponibles:**
 Blanco Marfil Perla Grafito

PS201 Placa con dimmer

8x12 cm



- PS201-B PS201-M PS201-PE PS201-GR

200 W
Policarbonato

MULTIVOLTAJE
PROTEGE TUS APARATOS

Inner 8 **Master** 80 **Fácil instalación** **Bolsa** **Incluye** **Colores disponibles:**
 Blanco Marfil Perla Grafito



PS302 Placa con toma coaxial



8x12cm



Policarbonato

- PS302-B
- PS302-M
- PS302-PE
- PS302-GR

MULTIVOLTAJE
PROTEGE TUS APARATOS

- | | | | | | |
|--------------|---------------|--------------------------|--------------|----------------|---|
| Inner | Master | Fácil instalación | Bolsa | Incluye | Colores disponibles: |
| 10 | 100 | | | | <input type="radio"/> Blanco <input type="radio"/> Marfil <input type="radio"/> Perla <input type="radio"/> Grafito |

PS402 Placa con toma de teléfono



8x12cm



Policarbonato

- PS402-B
- PS402-M
- PS402-PE
- PS402-GR

MULTIVOLTAJE
PROTEGE TUS APARATOS

- | | | | | | |
|--------------|---------------|--------------------------|--------------|----------------|---|
| Inner | Master | Fácil instalación | Bolsa | Incluye | Colores disponibles: |
| 10 | 100 | | | | <input type="radio"/> Blanco <input type="radio"/> Marfil <input type="radio"/> Perla <input type="radio"/> Grafito |

PS1201 Placa con 1 módulo



8x12cm



Policarbonato

- PS1201-B
- PS1201-M
- PS1201-PE
- PS1201-D
- PS1201-P
- PS1201-GR
- PS1201-N

- | | | | | | |
|--------------|---------------|--------------------------|--------------|----------------|--|
| Inner | Master | Fácil instalación | Bolsa | Incluye | Colores disponibles: |
| 20 | 200 | | | | <input type="radio"/> Blanco <input type="radio"/> Marfil <input type="radio"/> Dorado <input type="radio"/> Negro <input type="radio"/> Perla <input type="radio"/> Plata <input type="radio"/> Grafito |

* Las imágenes mostradas en este catálogo son con fines ilustrativos. IGOTO® se reserva el derecho de modificar la información sin previo aviso y no se hace responsable por omisiones o errores en este documento.



PS1202 Placa con 2 módulos

8x12 cm

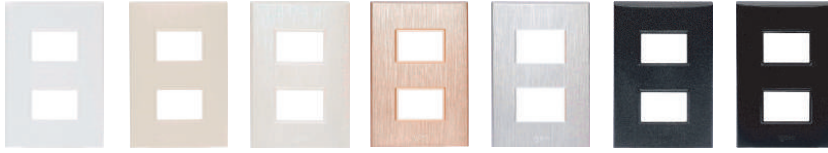

Policarbonato

○ PS1202-B ○ PS1202-M ○ PS1202-PE ○ PS1202-D ○ PS1202-P ○ PS1202-GR ● PS1202-N

Inner
20

Master
200



Colores disponibles:

○ Blanco ○ Marfil ○ Dorado
● Negro ○ Perla ○ Plata ● Grafito



NOM

PS1203 Placa con 3 módulos

8x12 cm



Policarbonato

○ PS1203-B ○ PS1203-M ○ PS1203-PE ○ PS1203-D ○ PS1203-P ○ PS1203-GR ● PS1203-N

Inner
20

Master
200



Colores disponibles:

○ Blanco ○ Marfil ○ Perla ○ Dorado ○ Plata ● Grafito
● Negro



NOM

PS1200 Placa ciega

8x12 cm



Policarbonato

○ PS1200-B ○ PS1200-M ○ PS1200-PE ○ PS1200-D ○ PS1200-P ○ PS1200-GR ● PS1200-N

Inner
20

Master
200



Colores disponibles:

○ Blanco ○ Marfil ○ Perla ○ Dorado ○ Plata ● Grafito
● Negro



NOM



LÍNEA ARMADA **STYLE PLUS**

LÍNEA DE PLACAS: LP LUGANO PLUS SP **STYLE PLUS** ZP ZURICH PLUS

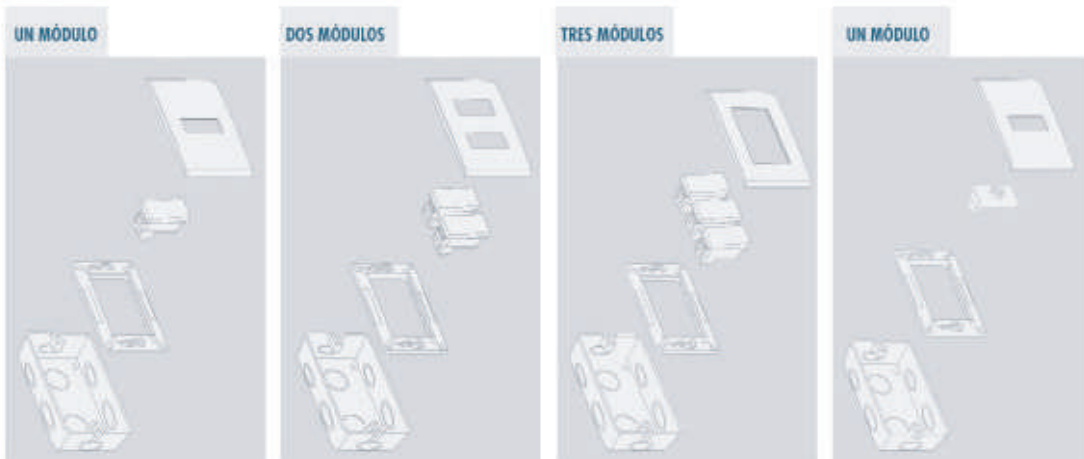

LÍNEA DE PLACAS: LP LUGANO PLUS SP **STYLE PLUS** ZP **ZURICH PLUS**

LÍNEA DE PLACAS **ZURICH PLUS**



PA105/2 Contacto duplex con placa

8 x 12 cm



PA105/2-B

PA105/2-BC

PA105/2-BN

PA105/2-B/N

PA105/2-M

PA105/2-MCA

Contacto 125-250 V~/15 A

Policarbonato



MULTIVOLTAJE
PROTEGE TUS APARATOS

Inner 10

Master 100

Fácil instalación

Bolsa

Incluye

Colores disponibles:

Blanco Blanco-Cromo Negro-Blanco Blanco-Negro Marfil Café-Marfil

* Las imágenes mostradas en este catálogo son con fines ilustrativos. IGOTO® se reserva el derecho de modificar la información sin previo aviso y no se hace responsable por omisiones o errores en este documento.



PA1201 Placa con 1 módulo con marco de color

8x12cm

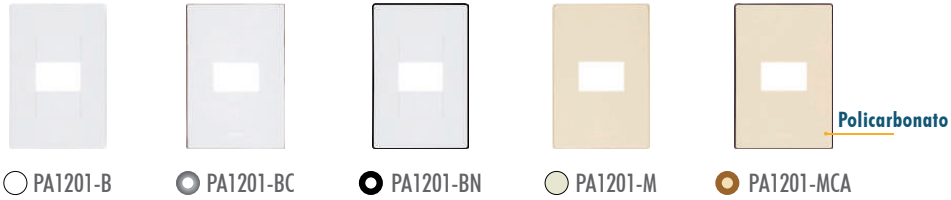

Inner 20 | **Master** 200 | **Fácil instalación**  | **Bolsa**  | **Incluye**  | **Colores disponibles:**

Blanco Blanco-Cromo Blanco-Negro Marfil Marfil-Café

GARANTÍA 10 AÑOS

NOM

PA1202 Placa con 2 módulos con marco de color

8x12cm

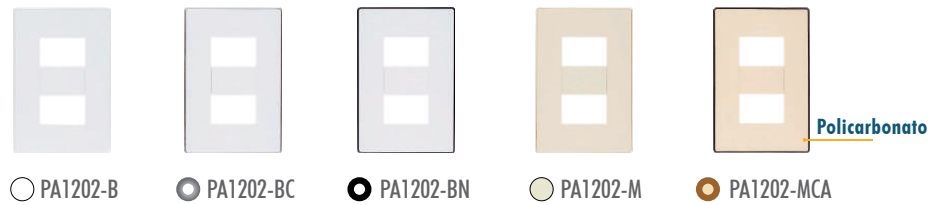

Inner 20 | **Master** 200 | **Fácil instalación**  | **Bolsa**  | **Incluye**  | **Colores disponibles:**

Blanco Blanco-Cromo Blanco-Negro Marfil Marfil-Café

GARANTÍA 10 AÑOS

NOM

PA1203 Placa con 3 módulos con marco de color

8x12cm

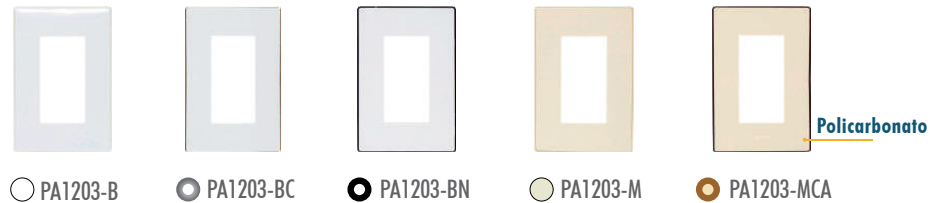

Inner 20 | **Master** 200 | **Fácil instalación**  | **Bolsa**  | **Incluye**  | **Colores disponibles:**

Blanco Blanco-Cromo Blanco-Negro Marfil Marfil-Café

GARANTÍA 10 AÑOS

NOM

➤ **LÍNEA DE PLACAS ZURICH PLUS**

LÍNEA DE PLACAS: **LP** LUGANO PLUS **SP** STYLE PLUS **ZP** ZURICH PLUS

PA1200 Placa ciega con marco de color

8x12 cm



○ PA1200-B ● PA1200-BC ● PA1200-BN ○ PA1200-M ● PA1200-MCA



Policarbonato

Inner 20 **Master** 200 **Fácil instalación** **Bolsa** **Incluye** **Colores disponibles:** ○ Blanco ● Blanco-Cromo ● Blanco-Negro ○ Marfil ● Marfil-Café

PA590 Sensor de movimiento

8x12 cm



○ PA590-B ○ PA590-M ● PA590-N



Policarbonato

Inner 8 **Master** 80 **Fácil instalación** **Bolsa** **Incluye** **Colores disponibles:** ○ Blanco ○ Marfil ● Negro

DIAGRAMAS DE MONTAJE

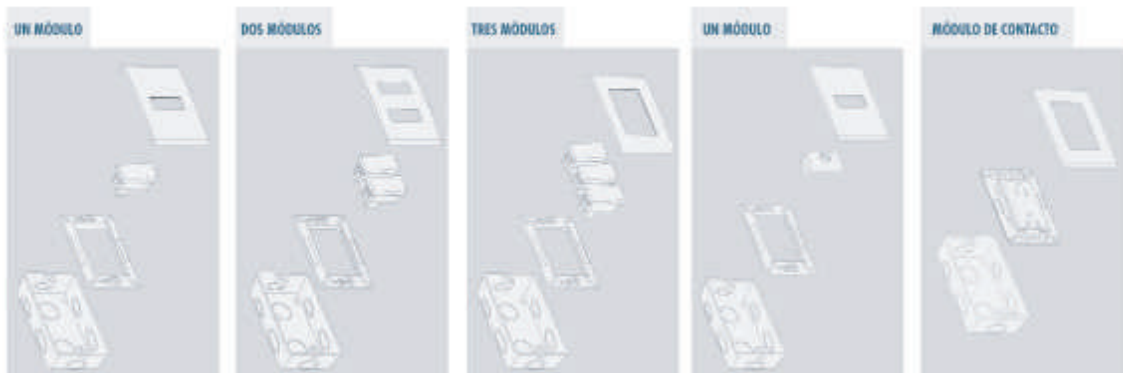

* Las imágenes mostradas en este catálogo son con fines ilustrativos. IGOTO® se reserva el derecho de modificar la información sin previo aviso y no se hace responsable por omisiones o errores en este documento.



COMPATIBLE CON LÍNEA DE PLACAS: **LP** LUGANO PLUS **SP** STYLE PLUS **ZP** ZURICH PLUS

MECANISMOS



B1512 Módulo de contacto dúplex



NOM



Contacto 125-250 V~/15 A
Policarbonato

B1512-B B1512-M B1512-N **MULTIVOLTAJE** PROTEGE TUS APARATOS

Inner: 6 Master: 144 Bolsa Fijado por presión
Colores disponibles: Marfil Blanco Negro
Compatible con: **ZP** **LP** **SP**

B1513 Módulo de contacto dúplex universal



NOM



125~/15 A
Policarbonato

B1513-B B1513-M B1513-N **MULTIVOLTAJE** PROTEGE TUS APARATOS

Inner: 6 Master: 144 Bolsa Colores disponibles: Marfil Blanco Negro
Compatible con: **ZP** **LP** **SP**

B1514 Contacto dúplex + USB y USBC

NUEVO



NOM



Contacto 125-250 V~/15 A
USB In Put 110-250 V~ Out Put 5 V~2.1 A
Frecuencia 50/60 Hz
Policarbonato

B1514-B B1514-M B1514-N **MULTIVOLTAJE** PROTEGE TUS APARATOS

Inner: 6 Master: 144 Bolsa Fijado por presión
Colores disponibles: Marfil Blanco Negro
Compatible con: **ZP** **LP** **SP**

D2087 Apagador de tarjeta



NOM



125~/30 A
Policarbonato

Incluye tarjeta D2087-B

Inner: 8 Master: 80 Bolsa Colores disponibles: Blanco

B5151 Apagador sencillo 3 módulos



NOM



Apagador 125-250 V~/10 A
Policarbonato

B5151-B B5151-M B5151-N **MULTIVOLTAJE** PROTEGE TUS APARATOS

Inner: 6 Master: 144 Fijado por presión Bolsa Compatible con: **ZP** **LP** **SP** Colores disponibles: Blanco Marfil Negro

B5152 Apagador escalera 3 módulos



○ B5152-B



○ B5152-M



● B5152-N

Apagador 125-250 V~/10 A

Policarbonato

MULTIVOLTAJE
PROTEGE TUS APARATOS

Inner 6 Master 144 Fijado por presión Bolsa Compatible con: **ZP** **LP** **SP** Colores disponibles: ○ Blanco ○ Marfil ● Negro

BN5151 Apagador 3 módulos con luz piloto



○ BN5151-B



○ BN5151-M



● BN5151-N

Apagador 125-250 V~/10 A

Policarbonato

MULTIVOLTAJE
PROTEGE TUS APARATOS

Inner 6 Master 144 Fijado por presión Bolsa Compatible con: **ZP** **LP** **SP** Colores disponibles: ○ Blanco ○ Marfil ● Negro

BN5152 Apagador escalera con luz piloto 3 módulos



○ BN5152-B



○ BN5152-M



● BN5152-N

Apagador 125-250 V~/10 A

Policarbonato

MULTIVOLTAJE
PROTEGE TUS APARATOS

Inner 6 Master 144 Fijado por presión Bolsa Compatible con: **ZP** **LP** **SP** Colores disponibles: ○ Blanco ○ Marfil ● Negro

* Las imágenes mostradas en este catálogo son con fines ilustrativos. IGOTO® se reserva el derecho de modificar la información sin previo aviso y no se hace responsable por omisiones o errores en este documento.



COMPATIBLE CON LÍNEA DE PLACAS: **LP** LUGANO PLUS **SP** STYLE PLUS **ZP** ZURICH PLUS

MECANISMOS 

B5251 Apagador sencillo 1.5 módulos



○ B5251-B



○ B5251-M

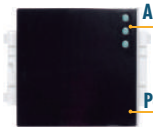

● B5251-N

Apagador 125-250 V~/10 A

Policarbonato

MULTIVOLTAJE
PROTEGE TUS APARATOS

Inner 12 **Master** 288 **Fijado por presión**  **Bolsa**  **Compatible con:**    **Colores disponibles:** ○ Blanco ○ Marfil ● Negro

B5252 Apagador escalera 1.5 módulos



○ B5252-B



○ B5252-M



● B5252-N

Apagador 125-250 V~/10 A

Policarbonato

MULTIVOLTAJE
PROTEGE TUS APARATOS

Inner 12 **Master** 288 **Fijado por presión**  **Bolsa**  **Compatible con:**    **Colores disponibles:** ○ Blanco ○ Marfil ● Negro

BN5251 Apagador 1.5 módulos con luz piloto



○ BN5251-B



○ BN5251-M



● BN5251-N

Apagador 125-250 V~/10 A

Policarbonato

MULTIVOLTAJE
PROTEGE TUS APARATOS

Inner 12 **Master** 288 **Fijado por presión**  **Bolsa**  **Compatible con:**    **Colores disponibles:** ○ Blanco ○ Marfil ● Negro



MECANISMOS

COMPATIBLE CON LÍNEA DE PLACAS: **LP** LUGANO PLUS **SP** STYLE PLUS **ZP** ZURICH PLUS

BN5252 Apagador escalera 1.5 módulos con luz piloto



○ BN5252-B



○ BN5252-M



● BN5252-N

Apagador 125-250 V~/10 A

Policarbonato

MULTIVOLTAJE
PROTEGE TUS APARATOS

Inner 12 **Master** 288 **Fijado por presión** **Bolsa** **Compatible con:** **ZP** **LP** **SP** **Colores disponibles:** ○ Blanco ○ Marfil ● Negro

B5451 Apagador doble de 1.5 módulos sencillos



○ B5451-B



○ B5451-M



● B5451-N

Apagador 125-250 V~/10 A

Policarbonato

MULTIVOLTAJE
PROTEGE TUS APARATOS

Inner 12 **Master** 288 **Fijado por presión** **Bolsa** **Compatible con:** **ZP** **LP** **SP** **Colores disponibles:** ○ Blanco ○ Marfil ● Negro

B5452 Apagador doble de 1.5 módulos escalera



○ B5452-B



○ B5452-M



● B5452-N

Apagador 125-250 V~/10 A

Policarbonato

MULTIVOLTAJE
PROTEGE TUS APARATOS

Inner 12 **Master** 288 **Fijado por presión** **Bolsa** **Compatible con:** **ZP** **LP** **SP** **Colores disponibles:** ○ Blanco ○ Marfil ● Negro

* Las imágenes mostradas en este catálogo son con fines ilustrativos. IGOTO® se reserva el derecho de modificar la información sin previo aviso y no se hace responsable por omisiones o errores en este documento.



COMPATIBLE CON LÍNEA DE PLACAS: **LP** LUGANO PLUS **SP** STYLE PLUS **ZP** ZURICH PLUS



B5351 Apagador sencillo de 1 módulo



Apagador 125-250 V~/10 A

Policarbonato

○ B5351-B

○ B5351-M

● B5351-N

MULTIVOLTAJE
PROTEGE TUS APARATOS

Inner 18 **Master** 432 **Fijado por presión**  **Bolsa**  **Compatible con:**    **Colores disponibles:** ○ Blanco ○ Marfil ● Negro

B5352 Apagador escalera 1 módulo



Apagador 125-250 V~/10 A

Policarbonato

○ B5352-B

○ B5352-M

● B5352-N

MULTIVOLTAJE
PROTEGE TUS APARATOS

Inner 18 **Master** 432 **Fijado por presión**  **Bolsa**  **Compatible con:**    **Colores disponibles:** ○ Blanco ○ Marfil ● Negro

BN5351 Apagador 1 módulo con luz piloto



Apagador 125-250 V~/10 A

Policarbonato

○ BN5351-B

○ BN5351-M

● BN5351-N

MULTIVOLTAJE
PROTEGE TUS APARATOS

Inner 18 **Master** 432 **Fijado por presión**  **Bolsa**  **Compatible con:**    **Colores disponibles:** ○ Blanco ○ Marfil ● Negro

BN5352 Apagador escalera 1 módulo con luz piloto



Apagador 125-250 V~/10 A

Policarbonato

○ BN5352-B

○ BN5352-M

● BN5352-N

MULTIVOLTAJE
PROTEGE TUS APARATOS

Inner 18	Master 432	Fijado por presión 	Bolsa 	Compatible con: ZP LP SP	Colores disponibles: ○ Blanco ○ Marfil ● Negro
--------------------	----------------------	-------------------------------	------------------	------------------------------------	--

B5332 Apagador 1 módulo de 4 vías



Apagador 125-250 V~/10 A

Policarbonato

○ B5332-B

○ B5332-M

● B5332-N

MULTIVOLTAJE
PROTEGE TUS APARATOS

Inner 18	Master 432	Fijado por presión 	Bolsa 	Compatible con: ZP LP SP	Colores disponibles: ○ Blanco ○ Marfil ● Negro
--------------------	----------------------	-------------------------------	------------------	------------------------------------	--

B2101 Contacto 1 módulo 2P+T



Contacto 125-250 V~/15 A

Policarbonato

○ B2101-B

○ B2101-M

● B2101-N

MULTIVOLTAJE
PROTEGE TUS APARATOS

Inner 18	Master 432	Fijado por presión 	Bolsa 	Compatible con: ZP LP SP	Colores disponibles: ○ Blanco ○ Marfil ● Negro
--------------------	----------------------	-------------------------------	------------------	------------------------------------	--

* Las imágenes mostradas en este catálogo son con fines ilustrativos. IGO™ se reserva el derecho de modificar la información sin previo aviso y no se hace responsable por omisiones o errores en este documento.



COMPATIBLE CON LÍNEA DE PLACAS: **LP** LUGANO PLUS **SP** STYLE PLUS **ZP** ZURICH PLUS

MECANISMOS



B3101 Contacto 1.5 módulos 2P+T



Contacto 125-250 V~/15 A

Policarbonato

B3101-B

B3101-M

B3101-N

MULTIVOLTAJE
PROTEGE TUS APARATOS

Inner 12	Master 288	Fijado por presión 	Bolsa 	Compatible con: <input type="radio"/> ZP <input type="radio"/> LP <input type="radio"/> SP	Colores disponibles: <input type="radio"/> Blanco <input type="radio"/> Marfil <input checked="" type="radio"/> Negro
--------------------	----------------------	-------------------------------	------------------	--	---

USBC Toma USB y USBC de 1 módulo

NUEVO



In Put 110-250 V~ : Out Put 5 V~ 3 A : Frecuencia 50/60 Hz

Policarbonato

USBC-B

USBC-M

USBC-N

MULTIVOLTAJE
PROTEGE TUS APARATOS

Inner 10	Master 240	Fijado por presión 	Bolsa 	Compatible con: <input type="radio"/> ZP <input type="radio"/> LP <input type="radio"/> SP	Colores disponibles: <input type="radio"/> Blanco <input type="radio"/> Marfil <input checked="" type="radio"/> Negro
--------------------	----------------------	-------------------------------	------------------	--	---

BUSB Toma conexión USB



In Put 110-250 V~ : Out Put 5 V~-2.1 A : Frecuencia 50/60 Hz

Policarbonato

BUSB-B

BUSB-M

BUSB-N

MULTIVOLTAJE
PROTEGE TUS APARATOS

Inner 18	Master 432	Fijado por presión 	Bolsa 	Compatible con: <input type="radio"/> ZP <input type="radio"/> LP <input type="radio"/> SP	Colores disponibles: <input type="radio"/> Blanco <input type="radio"/> Marfil <input checked="" type="radio"/> Negro
--------------------	----------------------	-------------------------------	------------------	--	---



2BUSB Toma doble conexión USB



In Put 110-250 V~ **Out Put** 5 V~-2.1 A **Frecuencia** 50/60 Hz

Policarbonato

- 2BUSB-B
 2BUSB-M
 2BUSB-N

MULTIVOLTAJE
PROTEGE TUS APARATOS

Inner 18 **Master** 432
 Fijado por presión
 Bolsa
 Compatible con: ZP LP SP
 Colores disponibles: Blanco Marfil Negro

BUL Módulo contacto y USB doble



USB **In Put** 110-250 V~ **Out Put** 5 V~-2.1 A **Frecuencia** 50/60 Hz

Contacto 125-250 V~/15 A

Policarbonato

- BUL-B
 BUL-M
 BUL-N

MULTIVOLTAJE
PROTEGE TUS APARATOS

Inner 6 **Master** 144
 Fijado por presión
 Bolsa
 Compatible con: ZP LP SP
 Colores disponibles: Blanco Marfil Negro

B1564 Toma de teléfono 4 hilos RJ-11



Policarbonato

- B1564-B
 B1564-M
 B1564-N

Inner 18 **Master** 432
 Fijado por presión
 Bolsa
 Compatible con: ZP LP SP
 Colores disponibles: Blanco Marfil Negro

* Las imágenes mostradas en este catálogo son con fines ilustrativos. IGOTO® se reserva el derecho de modificar la información sin previo aviso y no se hace responsable por omisiones o errores en este documento.



COMPATIBLE CON LÍNEA DE PLACAS: **LP** LUGANO PLUS **SP** STYLE PLUS **ZP** ZURICH PLUS

MECANISMOS



B1102 Toma coaxial TV



NOM



Policarbonato

○ B1102-B

○ B1102-M

● B1102-N

Inner
18

Master
432

Fijado por presión



Compatible con:



Colores disponibles:

○ Blanco ○ Marfil ● Negro

B3026 Toma de cómputo RJ-45 Cat5-E



NOM



Policarbonato

○ B3026-B

○ B3026-M

● B3026-N

Inner
18

Master
432

Fijado por presión



Compatible con:



Colores disponibles:

○ Blanco ○ Marfil ● Negro

B3020 Tapón ciego



NOM



Policarbonato

○ B3020-B

○ B3020-M

● B3020-N

Inner
54

Master
1296

Fijado por presión



Compatible con:



Colores disponibles:

○ Blanco ○ Marfil ● Negro





COMPATIBLE CON LÍNEA DE PLACAS: **LP** LUGANO PLUS **SP** STYLE PLUS **ZP** ZURICH PLUS

B3021 Tapón salida cable



Policarbonato

○ B3021-B

○ B3021-M

● B3021-N

Inner
36

Master
864

Fijado por presión



Compatible con:



Colores disponibles:

○ Blanco ○ Marfil ● Negro

B5401 Botón timbre



125-250 V~

Policarbonato

○ B5401-B

○ B5401-M

● B5401-N

MULTIVOLTAJE
PROTEGE TUS APARATOS

Inner
18

Master
432

Fijado por presión



Compatible con:



Colores disponibles:

○ Blanco ○ Marfil ● Negro

B3069 Zumbador (Ding Dong)

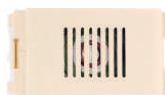

Policarbonato

○ B3069-B

○ B3069-M

● B3069-N

Inner
18

Master
432

Fijado por presión



Compatible con:



Colores disponibles:

○ Blanco ○ Marfil ● Negro

* Las imágenes mostradas en este catálogo son con fines ilustrativos. IGOTO® se reserva el derecho de modificar la información sin previo aviso y no se hace responsable por omisiones o errores en este documento.



COMPATIBLE CON LÍNEA DE PLACAS: **LP** LUGANO PLUS **SP** STYLE PLUS **ZP** ZURICH PLUS

MECANISMOS 

B5807-S Control de velocidad 200 W



200 W

Policarbonato

○ B5807-S-B

○ B5807-S-M

● B5807-S-N

Inner 8 **Master** 192 **Fijado por presión**  **Bolsa**  **Compatible con:** **ZP** **LP** **SP** **Colores disponibles:** ○ Blanco ○ Marfil ● Negro

B5172-S Dimmer 200W incandescente o halógeno



200 W

Policarbonato

○ B5172-S-B

○ B5172-S-M

● B5172-S-N

Inner 8 **Master** 192 **Fijado por presión**  **Bolsa**  **Compatible con:** **ZP** **LP** **SP** **Colores disponibles:** ○ Blanco ○ Marfil ● Negro





GF15A Contacto dúplex falla tierra

8 x 12 cm



○ GF15A-B



○ GF15A-M



● GF15A-N

Contacto 125-250 V~/15 A

Policarbonato



Inner: 6 Master: 60 Bolsa: Incluye: Colores disponibles: ○ Blanco ○ Marfil ● Negro

PN1200 Placa ciega de Nylon



○ PN1200-B



○ PN1200-B

ABS



Inner: 50 Master: 1000 Bolsa: Incluye: Colores disponibles: ○ Marfil ○ Blanco

PN1202 Placa 2 módulos de Nylon



○ PN1202-B



○ PN1202-B

ABS



Inner: 50 Master: 1000 Bolsa: Incluye: Colores disponibles: ○ Marfil ○ Blanco

* Las imágenes mostradas en este catálogo son con fines ilustrativos. IGOTO® se reserva el derecho de modificar la información sin previo aviso y no se hace responsable por omisiones o errores en este documento.



AC105/2
Contacto dúplex aterrizado



NOM

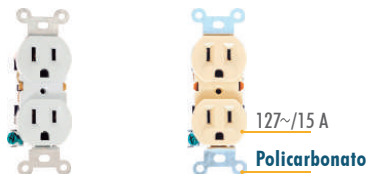

AC105/2-B AC105/2-M

Inner: 10 | Master: 200 | Bolsa: | Incluye: | Colores disponibles: Blanco Marfil

AC07/2
Apagador con contacto aterrizado



NOM



AC07/2-B AC07/2-M

Inner: 10 | Master: 200 | Bolsa: | Incluye: | Colores disponibles: Blanco Marfil

PN1202-NA
Placa 2 módulos de Nylon



NOM



PN1202-NA

Inner: 50 | Master: 1000 | Bolsa: | Incluye: | Colores disponibles: Naranja

AC105/2-NA
Contacto dúplex de tierra aislada



NOM



AC105/2-NA

Inner: 20 | Master: 200 | Bolsa: | Incluye: | Colores disponibles: Naranja

PI1202-P
Placa doble interperie



NOM



PI1202-P

Inner: 10 | Master: 200 | Bolsa: | Incluye: | Colores disponibles: Gris

AAL5351-B
Apagador largo sencillo



NOM



AAL5351-B

Inner: 50 | Master: 1000 | Bolsa: | Incluye: | Colores disponibles: Marfil

AAL5351-F Apagador largo



NOM



127~/10 A

Baquelita

○ AAL5351-F

Inner	Master	Bolsa	Incluye	Colores disponibles:
50	1000			○ Marfil

AAL5352-B Apagador largo tipo escalera



NOM



127~/10 A

Baquelita

○ AAL5352-B

Inner	Master	Bolsa	Incluye	Colores disponibles:
50	1000			○ Marfil

T-L Apagador largo timbre sencillo



NOM



127~/10 A

Baquelita

○ T-L

Inner	Master	Bolsa	Incluye	Colores disponibles:
50	1000			○ Marfil

ACL2101-B Contacto largo sencillo



NOM



127~/10 A

Baquelita

○ ACL2101-B

Inner	Master	Bolsa	Incluye	Colores disponibles:
50	1000			○ Marfil

ACR2101-B Contacto redondo



NOM



127~/6 A

Baquelita

○ ACR2101-B

Inner	Master	Bolsa	Incluye	Colores disponibles:
25	400			○ Marfil

AAR5351-B Apagador redondo



NOM



127~/6 A

Baquelita

○ AAR5351-B

Inner	Master	Bolsa	Incluye	Colores disponibles:
12	600			○ Marfil

* Las imágenes mostradas en este catálogo son con fines ilustrativos. IGOTO® se reserva el derecho de modificar la información sin previo aviso y no se hace responsable por omisiones o errores en este documento.



T-R-B
Apagador timbre redondo



○ T-R-B

127~/6 A
Baquelita



Inner	Master	Bolsa	Incluye	Colores disponibles:
25	400			○ Marfil

T-C
Apagador timbre cuadrado



○ T-C

127~/6 A
Baquelita



Inner	Master	Bolsa	Incluye	Colores disponibles:
30	600			○ Marfil

AAC5351-B
Apagador cuadrado



○ AAC5351-B ○ AAC5351-M

127~/6 A
Baquelita



Inner	Master	Bolsa	Incluye	Colores disponibles:
30	600			○ Blanco ○ Marfil

AC06-2M
Contacto dúplex polarizado



○ AC06-2M

127~/6 A
Frente Baquelita
Base ABS



Inner	Master	Bolsa	Incluye	Colores disponibles:
20	200			○ Marfil

AC06-M
Contacto dúplex aterrizado



○ AC06-M

127~/6 A
Frente Baquelita
Base ABS



Inner	Master	Bolsa	Incluye	Colores disponibles:
20	200			○ Marfil

ACC2101-M
Contacto cuadrado marfil



○ ACC2101-M

127 V- /6 A
Baquelita



Inner	Master	Bolsa	Incluye	Colores disponibles:
30	600			○ Marfil

AC03-M Contacto aterrizado triple
AC03/2-M Contacto aterrizado triple con clavija



127~/10 A

127~/10 A

○ AC03-M

Baquelita

○ AC03/2-M

Baquelita

Modelo	Inner	Master	Bolsa	Incluye	Colores disponibles:
AC03-M	25	400			○ Marfil
AC03/2-M	12	480			○ Marfil

AC2101-A/A Contacto aterrizado



125~/15 A

ABS

● AC2101-A/A

Inner	Master	Bolsa	Incluye	Colores disponibles:
25	300			● Amarillo

AC2101-A/N Contacto con



125~/15 A

ABS

● AC2101-A/N

Inner	Master	Bolsa	Incluye	Colores disponibles:
25	300			● Amarillo

CL-2P-MA Clavija polarizado con



125~/15 A

ABS

● CL-2P-MA

Inner	Master	Bolsa	Incluye	Colores disponibles:
25	400			● Amarillo

CL-2PT-MA Clavija aterrizada con abrazader metálica



125~/15 A

ABS

● CL-2PT-MA

Inner	Master	Bolsa	Incluye	Colores disponibles:
25	400			● Amarillo

CL-2PT-PA Clavija aterrizada con armazón de plástico



125~/15 A

ABS

● CL-2PT-PA

Inner	Master	Bolsa	Incluye	Colores disponibles:
25	300			● Amarillo

* Las imágenes mostradas en este catálogo son con fines ilustrativos. IGOTO® se reserva el derecho de modificar la información sin previo aviso y no se hace responsable por omisiones o errores en este documento.



TC-PL-C
Portalámpara con clavija



NOM



125~/15 A

660 W

Baqelita

● TC-PL-C

Inner	Master	Bolsa	Colores disponibles:
30	600		● Café

SO-P
Socket portalámpara



NOM



125~

660 W

Baqelita

● SO-P-C ● SO-P-N

Inner	Master	Bolsa	Colores disponibles:
20	600		● Café ● Negro
25	400		

SO-T
Portalámpara con doble ladrón



NOM



125~/15 A

660 W

Baqelita

● SO-T-C

○ SO-T-M

Inner	Master	Bolsa	Colores disponibles:
20	400		● Café ○ Marfil

SO-TA Portalámpara con doble ladrón e interruptor de cadena



NOM



125~/15 A

660 W

Baqelita

● SO-TA-C

○ SO-TA-M

Inner	Master	Bolsa	Colores disponibles:
12	400		● Café ○ Marfil
12	600		

SO-C
Socket circular



NOM



125~/15 A

Baqelita

○ SO-C

Inner	Master	Bolsa	Colores disponibles:
12	240		○ Marfil

AM01
Adaptador triple



NOM



125~/15 A

PCV/Cobre

● AM01

Inner	Master	Blister	Colores disponibles:
24	72		● Naranja

AM02 - AM03
Adaptador triple rectangular

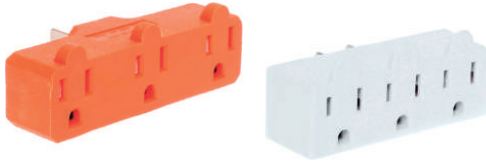

● AM02 125~/15 A ○ AM03 125~/15 A

Inner	Master	Colores disponibles:	Blister
24	72	● Naranja PVC/Cobre	
24	144	○ Blanco ABS/Cobre	



AM04
Adaptador triple triangular



○ AM04

125~/15 A
ABS/Cobre

Inner	Master	Blister	Colores disponibles:
24	144		○ Blanco



AM05
Multipuerto 6 contactos



○ AM05

125~/15 A
ABS/Cobre

Inner	Master	Blister	Colores disponibles:
10	50		○ Blanco



AM06 Multicontacto doble con 2 entradas USB



○ AM06

Joules 220 J
USB 2.1 A
125~/15 A
ABS/Cobre

Inner	Master	Blister	Colores disponibles:
10	40		○ Blanco



AM07 Multicontacto triple con 2 entradas USB



○ AM07

Joules 220 J
USB 2.1 A
125~/15 A
ABS/Cobre

Inner	Master	Blister	Colores disponibles:
10	40		○ Blanco



AM08 Adaptador clavija plano triple contacto



○ AM08

125~/15 A
ABS/Cobre

Inner	Master	Blister	Colores disponibles:
50	200		○ Blanco



* Las imágenes mostradas en este catálogo son con fines ilustrativos. IGOTO® se reserva el derecho de modificar la información sin previo aviso y no se hace responsable por omisiones o errores en este documento.



AM09 Adaptador clavija plano triple contacto



○ AM09

125~/15 A
ABS/Cobre

Inner 50 Master 200 Blister Colores disponibles: ○ Blanco



AM10 Multicontacto triple aterrizado con indicador



○ AM10

125~/15 A
ABS/Cobre

Inner 50 Master 200 Blister Colores disponibles: ○ Blanco



AM11 Multicontacto triple con 2 entradas USB y soporte para celular

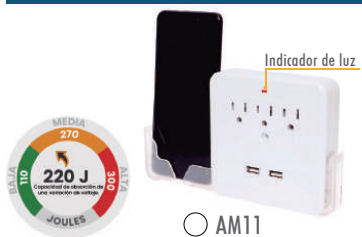

○ AM11

Joules 220 J
USB 2.1 A
125~/15 A
ABS/Cobre

Inner 50 Master 100 Blister Colores disponibles: ○ Blanco



AM12 Adaptador triple de cubo



○ AM12

125~/15 A
ABS/Cobre

Inner 50 Master 200 Blister Colores disponibles: ○ Blanco



AM13 Adaptador de clavija

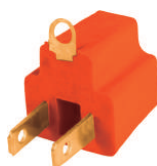

● AM13

125~/15 A
PVC/Cobre

Inner 50 Master 500 Colores disponibles: ● Naranja



3AM13 Set de 3 adaptador de clavija

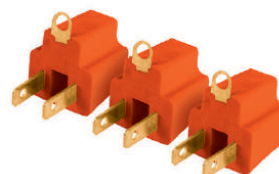

● 3AM13

125~/15 A
PVC/Cobre

Inner 50 Master 200 Blister Colores disponibles: ● Naranja



➤ EXTENSIONES ELÉCTRICAS

ED13-B
Extensión domestica



3 Entradas

○ ED13-B

Código	Tamaño	Inner	Master	Colores disponibles:
ED13-2B	2 m	-	50	○ Blanco
ED13-3B	3 m	-	50	○ Blanco
ED13-4B	4 m	-	50	○ Blanco
ED13-5B	5 m	-	50	○ Blanco
ED13-6B	6 m	-	50	○ Blanco
ED13-8B	8 m	-	50	○ Blanco
ED13-10B	10 m	-	50	○ Blanco

ER13-NA
Extensión uso rudo



3 Entradas

● ER13-NA

Código	Tamaño	Inner	Master	Colores disponibles:
ER13-2NA	2 m	-	50	● Naranja
ER13-3NA	3 m	-	40	● Naranja
ER13-4NA	4 m	-	30	● Naranja
ER13-5NA	5 m	-	25	● Naranja
ER13-6NA	6 m	-	20	● Naranja
ER13-8NA	8 m	-	20	● Naranja
ER13-10NA	10 m	-	16	● Naranja
ER13-12NA	12 m	-	16	● Naranja
ER13-15NA	15 m	-	12	● Naranja
ER13-20NA	20 m	-	10	● Naranja
ER13-25NA	25 m	-	8	● Naranja
ER13-30NA	30 m	-	6	● Naranja

ED13-1B
Mini extensión doméstica



6 Entradas

○ ED13-1B

Inner	Master	Tamaño
-	100	10 cm



* Las imágenes mostradas en este catálogo son con fines ilustrativos. IGOTO® se reserva el derecho de modificar la información sin previo aviso y no se hace responsable por omisiones o errores en este documento.



INTERRUPTORES **TERMOMAGNÉTICOS**



igoto SWISS

5 VECES MÁS SENCIBLE AL CORTOCIRCUITO

Disponibles en : 15A, 20A, 30A, 40A Y 50A

LÍNEA DIRECTA DE INTERRUPTORES PARA LA PROTECCIÓN DE DESCARGAS ELÉCTRICAS

MAYOR DURABILIDAD

BOBINA DE DISPARO MAGNÉTICO DE COBRE

CONTACTO PUNTAS DE PLATA

CÁMARA DE EXTINCIÓN

BORDE DE SALIDA DE COBRE

DISPOSITIVO TÉRMICO BIMETAL

1 POLO

2 POLOS

3 POLOS

IN100 Interruptor termomagnético 1 polo



NOM



120/240 V~

Capacidad interruptiva 10 kA

Código	Corriente	Inner	Master	Frecuencia	Material
IN1001	15 A	12	120	60 Hz	Poliéster
IN1002	20 A				
IN1003	30 A				
IN1004	40 A				
IN1005	50 A				

IN200 Interruptor termomagnético 2 polos



NOM



120/240 V~

Capacidad interruptiva 10 kA

Código	Corriente	Inner	Master	Frecuencia	Material
IN2001	15 A	6	60	60 Hz	Poliéster
IN2002	20 A				
IN2003	30 A				
IN2004	40 A				
IN2005	50 A				

IN300 Interruptor termomagnético 3 polos



NOM



120/240 V~

Capacidad interruptiva 10 kA

Código	Corriente	Código	Corriente	Inner	Master	Frecuencia	Material
IN3001	15 A	IN3003	30 A	4	40	60 Hz	Poliéster
IN3002	20 A	IN3004	40 A				
		IN3005	50 A				



▶ EXTRACTORES



Ex6-18W - Ex4-16W Extractor de aire empotrable



○ Ex6-18W



○ Ex4-16W

125~115 A
Ruido 35 dB
Doble embainado de cobre
Cuerpo ABS

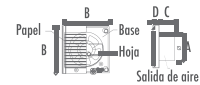

Modelo	Ø A	B	C	D
Ex6-18W	148 mm	200 mm	75 mm	12 mm
Modelo	Ø A	B	C	D
Ex4-16W	98 mm	157 mm	60 mm	21 mm



Modelo	Inner	Master	Volumen aire	Modelo	Inner	Master	Volumen aire	Fácil instalación	Colores disponibles:
Ex6-18W	-	20	320m ³ /h	Ex4-16W	-	30	130m ³ /h		○ Blanco



* Las imágenes mostradas en este catálogo son con fines ilustrativos. IGOTO® se reserva el derecho de modificar la información sin previo aviso y no se hace responsable por omisiones o errores en este documento.





Foco LED A55

Modelo	F20105	Luz Cálida	3 000 °K	Modelo	F10105	Luz Fría	6 500 °K
--------	--------	------------	----------	--------	--------	----------	----------

Consumo 5 W

Flujo 450 lm

Inner 10
Master 100

Altura 10 cm

127 V ~
5 W
E27

3 000 °k
6 500 °k

127 V ~ **E27** **30 000 h** **OMNIDIRECCIONAL**

Reemplaza	Frecuencia	Tipo de bulbo	Intensidad de corriente
40 W	60 Hz	A	80 mA

2400-3000 °K 4100-5700°K 6500-7000°K

Foco LED A55

Modelo	F20107	Luz Cálida	3 000 °K	Modelo	F10107	Luz Fría	6 500 °K
--------	--------	------------	----------	--------	--------	----------	----------

Consumo 7 W

Flujo 630 lm

Inner 10
Master 100

Altura 10 cm

127 V ~
7 W
E27

3 000 °k
6 500 °k

127 V ~ **E27** **30 000 h** **OMNIDIRECCIONAL**

Reemplaza	Frecuencia	Tipo de bulbo	Intensidad de corriente
40 W	60 Hz	A	110 mA

2400-3000 °K 4100-5700°K 6500-7000°K

* Las imágenes mostradas en este catálogo son con fines ilustrativos. IGOTO® se reserva el derecho de modificar la información sin previo aviso y no se hace responsable por omisiones o errores en este documento.

FOCOS LED E27

Foco LED A60

Modelo	Luz Cálida	Modelo	Luz Fría
F20109	3 000 °K	F10109	6 500 °K

Consumo **9 W**
Flujo **810 lm**

Inner 10
Master 100

Altura  11 cm



igoto

127 V ~
9 W
E27

127 V ~ E27 30 000 h OMNIDIRECCIONAL

Reemplaza	Frecuencia	Tipo de bulbo	Intensidad de corriente
60 W	60 Hz	A	140 mA

2400-3000 °K 4100-5700 °K 6500-7000 °K

Foco LED A60

Modelo	Luz Cálida	Modelo	Luz Fría
F20112	3 000 °K	F10112	6 500 °K

Consumo **12 W**
Flujo **1080 lm**

Inner 10
Master 100

Altura  11 cm



igoto

127 V ~
12 W
E27

127 V ~ E27 30 000 h OMNIDIRECCIONAL

Reemplaza	Frecuencia	Tipo de bulbo	Intensidad de corriente
75 W	60 Hz	A	190 mA

2400-3000 °K 4100-5700 °K 6500-7000 °K

Foco LED A60

Modelo	Luz Cálida	Modelo	Luz Fría
F20115	3 000 °K	F10115	6 500 °K

Consumo **15 W**
Flujo **1350 lm**

Inner 10
Master 100

Altura  12 cm



igoto

127 V ~
15 W
E27

127 V ~ E27 30 000 h OMNIDIRECCIONAL

Reemplaza	Frecuencia	Tipo de bulbo	Intensidad de corriente
100 W	60 Hz	A	240 mA

2400-3000 °K 4100-5700 °K 6500-7000 °K

Foco LED G45

Modelo	Luz Cálida	Modelo	Luz Fría
F20204	3 000 °K	F10204	6 500 °K

Consumo **4 W**
Flujo **360 lm**

Inner 10
Master 100

Altura  10.5 cm



igoto

127 V ~
4 W
E27

127 V ~ E27 30 000 h OMNIDIRECCIONAL

Reemplaza	Frecuencia	Tipo de bulbo	Intensidad de corriente
25 W	60 Hz	G	70 mA

2400-3000 °K 4100-5700 °K 6500-7000 °K

* Las imágenes mostradas en este catálogo son con fines ilustrativos. IGO TO® se reserva el derecho de modificar la información sin previo aviso y no se hace responsable por omisiones o errores en este documento.



PAQUETE DE FOCOS LED E27

Foco LED FE10709

Consumo 9 W

Flujo 720 lm

Inner Master 100

Altura



Modelo Luz Fría
FE10709 6 500 °K



NOM



127 V ~



E27



15 000 h



OMNIDIRECCIONAL

Reemplaza 60 W	Frecuencia 60 Hz	Tipo de bulbo A	Intensidad de corriente 180 mA
----------------	------------------	-----------------	--------------------------------



Foco LED A55

Consumo 5 W

Flujo 450 lm

Inner 1 Master 30

Altura



Modelo Luz Cálida Modelo Luz Fría
F3P20105 3 000 °K F3P10105 6 500 °K



LED

NOM



127 V ~



E27



30 000 h



OMNIDIRECCIONAL

Reemplaza 40 W	Frecuencia 60 Hz	Tipo de bulbo A	Intensidad de corriente 80 mA
----------------	------------------	-----------------	-------------------------------

2400-3000 °K 4100-5700 °K 6500-7000 °K

Foco LED A55

Consumo 7 W

Flujo 630 lm

Inner 1 Master 30

Altura



Modelo Luz Cálida Modelo Luz Fría
F3P20107 3 000 °K F3P10107 6 500 °K



LED

NOM



127 V ~



E27



30 000 h



OMNIDIRECCIONAL

Reemplaza 40 W	Frecuencia 60 Hz	Tipo de bulbo A	Intensidad de corriente 110 mA
----------------	------------------	-----------------	--------------------------------

2400-3000 °K 4100-5700 °K 6500-7000 °K

▶ PAQUETE DE FOCOS LED E27

Foco LED A60 Modelo Luz Cálida Modelo Luz Fría
F3P20109 3 000 °K F3P10109 6 500 °K



Consumo 9 W

Flujo 810 lm

Inner 1
Master 30

Altura
 11cm



127 V ~ E27 30 000 h OMNIDIRECCIONAL

Reemplaza	Frecuencia	Tipo de bulbo	Intensidad de corriente
60 W	60 Hz	A	140 mA
2400-3000 °K		4100-5700 °K	6500-7000 °K

Foco LED A60 Modelo Luz Cálida Modelo Luz Fría
F10P20109 3 000 °K F10P10109 6 500 °K



Consumo 9 W

Flujo 810 lm

Inner 1
Master 10

Altura
 11cm



127 V ~ E27 30 000 h OMNIDIRECCIONAL

Reemplaza	Frecuencia	Tipo de bulbo	Intensidad de corriente
60 W	60 Hz	A	140 mA
2400-3000 °K		4100-5700 °K	6500-7000 °K

NUEVO

Foco LED A60 Modelo Luz Cálida Modelo Luz Fría
F3P20112 3 000 °K F3P10112 6 500 °K



Consumo 12 W

Flujo 1080 lm

Inner 1
Master 30

Altura
 11cm



127 V ~ E27 30 000 h OMNIDIRECCIONAL

Reemplaza	Frecuencia	Tipo de bulbo	Intensidad de corriente
75 W	60 Hz	A	190 mA
2400-3000 °K		4100-5700 °K	6500-7000 °K

NUEVO

Foco LED A60 Modelo Luz Cálida Modelo Luz Fría
F3P20115 3 000 °K F3P10115 6 500 °K



Consumo 15 W

Flujo 1350 lm

Inner 1
Master 30

Altura
 12 cm



127 V ~ E27 30 000 h OMNIDIRECCIONAL

Reemplaza	Frecuencia	Tipo de bulbo	Intensidad de corriente
100 W	60 Hz	A	240 mA
2400-3000 °K		4100-5700 °K	6500-7000 °K

* Las imágenes mostradas en este catálogo son con fines ilustrativos. IGOTO® se reserva el derecho de modificar la información sin previo aviso y no se hace responsable por omisiones o errores en este documento.





Foco LED T80	Modelo	Luz Cálida	Modelo	Luz Fría
	F20520	3 000 °K	F10520	6 500 °K

Consumo 20 W

Flujo 1800 lm

Inner 1
Master 50

Medidas
8 cm | 11.9 cm



MULTIVOLTAJE
PROTEGE TUS APARATOS



100-240 V~



E27



30 000 h



OMNIDIRECCIONAL

Reemplaza 150 W	Frecuencia 60 Hz	Tipo de bulbo T	Intensidad de corriente 400 mA
------------------------	-------------------------	------------------------	---------------------------------------

2400-3000 °K | 4100-5700 °K | 6500-7000 °K

Foco LED T100	Modelo	Luz Cálida	Modelo	Luz Fría
	F20530	3 000 °K	F10530	6 500 °K

Consumo 30 W

Flujo 2700 lm

Inner 1
Master 25

Medidas
10 cm | 15.2 cm



MULTIVOLTAJE
PROTEGE TUS APARATOS



100-240 V~



E27



30 000 h



OMNIDIRECCIONAL

Reemplaza 200 W	Frecuencia 60 Hz	Tipo de bulbo T	Intensidad de corriente 500 mA
------------------------	-------------------------	------------------------	---------------------------------------

2400-3000 °K | 4100-5700 °K | 6500-7000 °K



FOCOS LED ALTA POTENCIA

Foco LED T120

Modelo	Luz Cálida	Modelo	Luz Fría
F20540	3 000 °K	F10540	6 500 °K



Consumo
40 W

Flujo
3600 lm

Inner 1
Master 20

Altura



MULTIVOLTAJE
PROTEGE TUS APARATOS



100-240 V~

E27

30 000 h

OMNIDIRECCIONAL

Reemplaza	Frecuencia	Tipo de bulbo	Intensidad de corriente
300 W	60 Hz	T	700 mA
	2400-3000 °K	4100-5700 °K	6500-7000 °K

Foco LED T140

Modelo	Luz Cálida	Modelo	Luz Fría
F20550	3 000 °K	F10550	6 500 °K



Consumo
50 W

Flujo
4500 lm

Inner 1
Master 10

Altura



MULTIVOLTAJE
PROTEGE TUS APARATOS



100-240 V~

E27

30 000 h

OMNIDIRECCIONAL

Reemplaza	Frecuencia	Tipo de bulbo	Intensidad de corriente
400 W	60 Hz	T	900 mA
	2400-3000 °K	4100-5700 °K	6500-7000 °K

Foco LED T140 F10870



Consumo
70 W

Flujo
6300 lm

Inner 1
Master 10

Altura



MULTIVOLTAJE
PROTEGE TUS APARATOS



100-277 V~

E27

30 000 h

OMNIDIRECCIONAL

Reemplaza	Frecuencia	Tipo de bulbo	Intensidad de corriente
600 W	60 Hz	T	1000 mA

Foco LED T150 F108100



Consumo
100 W

Flujo
9000 lm

Inner 1
Master 10

Altura



MULTIVOLTAJE
PROTEGE TUS APARATOS



100-277 V~

E27

30 000 h

OMNIDIRECCIONAL

Reemplaza	Frecuencia	Tipo de bulbo	Intensidad de corriente
900 W	60 Hz	T	1400 mA

* Las imágenes mostradas en este catálogo son con fines ilustrativos. IGOTO® se reserva el derecho de modificar la información sin previo aviso y no se hace responsable por omisiones o errores en este documento.



FOCOS LED **ALTA POTENCIA** 

Foco LED T160
F10570

Consumo
70 W

Flujo
6300 lm

Inner 1
Master 10

Altura
13.8 cm | 20 cm



Foco LED T180
F105100

Consumo
100 W

Flujo
9000 lm

Inner 1
Master 10

Altura
13.8 cm | 21.1 cm



MULTIVOLTAJE
PROTEGE TUS APARATOS



100-277 V~

E40/MOGUL

30 000 h

OMNIDIRECCIONAL

Reemplaza	Frecuencia	Tipo de bulbo	Intensidad de corriente
600 W	60 Hz	T	1000 mA

MULTIVOLTAJE
PROTEGE TUS APARATOS



100-277 V~

E40/MOGUL

30 000 h

OMNIDIRECCIONAL

Reemplaza	Frecuencia	Tipo de bulbo	Intensidad de corriente
900 W	60 Hz	T	1400 mA



FOCOS LED DICROICO

Foco LED GU10 Modelo Luz Cálida Modelo Luz Fría
F20303 3 000 °K F10303 6 500 °K



Consumo 3 W

Flujo 230 lm

**Inner 10
Master 100**



127 V ~ GU10 30 000 h DIRECCIONAL 100°

Reemplaza	Frecuencia	Tipo de bulbo	Intensidad de corriente
15 W	60 Hz	MR	50 mA

2400-3000 °K 4100-5700 °K 6500-7000 °K

Foco LED GU10 Modelo Luz Cálida Modelo Luz Fría
F20305 3 000 °K F10305 6 500 °K



Consumo 5 W

Flujo 375 lm

**Inner 10
Master 100**



127 V ~ GU10 30 000 h DIRECCIONAL 100°

Reemplaza	Frecuencia	Tipo de bulbo	Intensidad de corriente
40 W	60 Hz	MR	80 mA

2400-3000 °K 4100-5700 °K 6500-7000 °K

Foco LED GU10 Modelo Luz Cálida Modelo Luz Fría
F20307 3 000 °K F10307 6 500 °K



Consumo 7 W

Flujo 525 lm

**Inner 10
Master 100**



127 V ~ GU10 30 000 h DIRECCIONAL 100°

Reemplaza	Frecuencia	Tipo de bulbo	Intensidad de corriente
40 W	60 Hz	MR	110 mA

2400-3000 °K 4100-5700 °K 6500-7000 °K

Foco LED GU10 Modelo Luz Cálida Modelo Luz Fría
FG20307 3 000 °K FG10307 6 500 °K



Consumo 7 W

Flujo 525 lm

**Inner 10
Master 100**



127 V ~ GU10 30 000 h DIRECCIONAL 35°

Reemplaza	Frecuencia	Tipo de bulbo	Intensidad de corriente
40 W	60 Hz	MR	110 mA

2400-3000 °K 4100-5700 °K 6500-7000 °K

* Las imágenes mostradas en este catálogo son con fines ilustrativos. IGOTO® se reserva el derecho de modificar la información sin previo aviso y no se hace responsable por omisiones o errores en este documento.



FOCOS LED **DICROICO** 

Foco LED MR16 Modelo Luz Cálida Modelo Luz Fría
F20403 3 000 °K F10403 6 500 °K



Consumo 3 W

Flujo 230 lm

Inner 10
Master 100



NOM

127 V ~	GU5.3	30 000 h	DIRECCIONAL 100°
Reemplaza 15 W	Frecuencia 60 Hz	Tipo de bulbo MR	Intensidad de corriente 50 mA
2400-3000 °K		4100-5700 °K 6500-7000 °K	

Foco LED MR16 Modelo Luz Cálida Modelo Luz Fría
F20405 3 000 °K F10405 6 500 °K



Consumo 5 W

Flujo 370 lm

Inner 10
Master 100



NOM

127 V ~	GU5.3	30 000 h	DIRECCIONAL 100°
Reemplaza 40 W	Frecuencia 60 Hz	Tipo de bulbo MR	Intensidad de corriente 80 mA
2400-3000 °K		4100-5700 °K 6500-7000 °K	

Foco LED MR16 Modelo Luz Cálida Modelo Luz Fría
F20407 3 000 °K F10407 6 500 °K



Consumo 7 W

Flujo 500 lm

Inner 10
Master 100



NOM

127 V ~	GU5.3	30 000 h	DIRECCIONAL 100°
Reemplaza 40 W	Frecuencia 60 Hz	Tipo de bulbo MR	Intensidad de corriente 110 mA
2400-3000 °K		4100-5700 °K 6500-7000 °K	

Foco LED MR16 Modelo Luz Cálida Modelo Luz Fría
FG20407 3 000 °K FG10407 6 500 °K



Consumo 7 W

Flujo 500 lm

Inner 10
Master 100



NOM

127 V ~	GU5.3	30 000 h	DIRECCIONAL 35°
Reemplaza 40 W	Frecuencia 60 Hz	Tipo de bulbo MR	Intensidad de corriente 110 mA
2400-3000 °K		4100-5700 °K 6500-7000 °K	



Luminario de LED para empotrar

Modelo	Luz Cálida	Modelo	Luz Fría
DL20106	3 000 °K	DL10106	6 500 °K



Consumo
6 W

Flujo
360 lm

Inner -
Master 100

Diámetro



MULTIVOLTAJE
PROTEGE TUS APARATOS



85-265 V- 15 000 h

Amperaje	Frecuencia	Grado de protección
0,05 A	50/60 Hz	IP 20

Luminario de LED para empotrar

Modelo	Luz Cálida	Modelo	Luz Fría
DL20109	3 000 °K	DL10109	6 500 °K



Consumo
9 W

Flujo
480 lm

Inner -
Master 100

Diámetro



MULTIVOLTAJE
PROTEGE TUS APARATOS



85-265 V- 15 000 h

Amperaje	Frecuencia	Grado de protección
0,07 A	50/60 Hz	IP 20

* Las imágenes mostradas en este catálogo son con fines ilustrativos. IGOTO® se reserva el derecho de modificar la información sin previo aviso y no se hace responsable por omisiones o errores en este documento.



LUMINARIOS DOWNLIGHT

Luminario de LED para empotrar

Modelo	Luz Cálida	Modelo	Luz Fría
DL20115	3 000 °K	DL10115	6 500 °K

Consumo 15 W

Flujo 1 300 lm

Inner -
Master 40

Diámetro 17,3 cm

1 300 lm

v 85 - 265 V-

15 W

MULTIVOLTAJE
PROTEGE TUS APARATOS

85-265 V- 15 000 h

Amperaje	Frecuencia	Grado de protección
0,15 A	50/60 Hz	IP 20

Luminario de LED para empotrar

Modelo	Luz Cálida	Modelo	Luz Fría
DL20120	3 000 °K	DL10120	6 500 °K

Consumo 20 W

Flujo 1 700 lm

Inner -
Master 20

Diámetro 22,9 cm

1 700 lm

v 85 - 265 V-

20 W

MULTIVOLTAJE
PROTEGE TUS APARATOS

85-265 V- 15 000 h

Amperaje	Frecuencia	Grado de protección
0,18 A	50/60 Hz	IP 20

ELIGE EL GABINETE IGOTO IDEAL

- LED** Luz con tecnología LED.
- Tiempo aproximado de vida 30,000 horas.
- Multivoltaje 110-240 V~
- Fácil instalación.

LOS GABINETES IGOTO ESTAN PROTEGIDOS CONTRA:

IP20 Objetos con diámetro superior a 12 mm	IP65 Aprecha de polvo.
Goteo con una inclinación de 15°	Chorros de agua.

DIFERENTE INTENSIDAD TEMPERATURA

Los gabinetes iGoto varían de intensidad y temperatura dependiendo de los tubos con los que se instalen (T5 - T8).

ESPACIOS RECOMENDADOS	INDOOR	OUTDOOR	ENTRETENIMIENTO
	 Closet	 Estadios deportivos	 Sauna/Spa
	 Oficinas	 Zonas verdes	 Museos
	 Hospitales	 Estacionamientos	 Acuarios



NUEVO
TUBO LED T8 CRISTAL TRANSPARENTE

LUZ
6500 K



MULTIVOLTAJE
100-240 V



T8



TUBO
CRISTAL



CONEXIÓN POR
AMBOS LADOS

MODELO	Potencia mA	Hz	CONSUMO DE ENERGÍA EN OPERACIÓN	BASE	W	LUMENS	MEDIDAS
TL0109	150	60	8.89 Wh	G13	9	900	60
TL0118	300	60	17.98 Wh	G13	18	1800	120
TL0136	580	60	35.89 Wh	FA8	36	3600	240

2400-3000 °K 4100-5700°K 6500-7000°K

NUEVO
TUBO LED T8 CRISTAL OPALINO

LUZ
6500 K



MULTIVOLTAJE
100-240 V



T8



TUBO
CRISTAL



CONEXIÓN POR
AMBOS LADOS

MODELO	Potencia mA	Hz	CONSUMO DE ENERGÍA EN OPERACIÓN	BASE	W	LUMENS	MEDIDAS
TL0209	150	60	8.89 Wh	G13	9	900	60
TL0218	300	60	17.98 Wh	G13	18	1800	120
TL0236	580	60	35.89 Wh	FA8	36	3600	240

2400-3000 °K 4100-5700°K 6500-7000°K

* Las imágenes mostradas en este catálogo son con fines ilustrativos.
IGOTO® se reserva el derecho de modificar la información sin previo aviso y no se hace responsable por omisiones o errores en este documento.





igoto

ILUMINA TUS ESPACIOS

NUEVO
REGLETA LED T5 INTERCONECTABLE
OPALINO

LUZ
6500 K



NOM



MULTIVOLTAJE
100-240 V



T5



DIFUSOR DE
POLICARBONATO BASE PVC

MODELO	Potencia mA Hz	CONSUMO DE ENERGIA EN OPERACIÓN	W	LUMENS	MEDIDAS
T10209	150 60	8.89 Wh	9	810	60 cm
T10218	300 60	17.98 Wh	18	1620	120 cm

2400-3000 °K 4100-5700° K 6500-7000° K

NUEVO
REGLETA LED T5 INTERCONECTABLE
TRANSPARENTE

LUZ
6500 K



NOM



MULTIVOLTAJE
100-240 V



T5



DIFUSOR DE
POLICARBONATO BASE PVC

MODELO	Potencia mA Hz	CONSUMO DE ENERGIA EN OPERACIÓN	W	LUMENS	MEDIDAS
T10109	150 60	8.89 Wh	9	810	60 cm
T10118	300 60	17.98 Wh	18	1620	120 cm

2400-3000 °K 4100-5700° K 6500-7000° K



GABINETES Y LUMINARIOS LED

Gabinete a prueba de vapor

Modelo
GV04

Potencia
recomendada
2x18W=36W

Inner 1
Master 8

Difusor policarbonato



Utiliza 2 tubos
No incluye tubos

Frecuencia	Peso	Material
50-60 Hz	1.2 kg	Cuerpo ABS, Difusor policarbonato

2400-3000 °K 4100-5700 °K 6500-7000 °K



Gabinete a prueba de vapor con tubos

Modelo
GV05

Potencia
2x18W=36W

Flujo
3 200 lm

Inner 1
Master 8

Difusor policarbonato

MULTIVOLTAJE
PROTEGE TUS APARATOS



85-265 V



Utiliza 2 tubos
Incluye tubos T8



Luz fría
6500 K

Frecuencia	Peso	Material
50-60 Hz	1.8 kg	Cuerpo ABS, Difusor policarbonato



Luminario de rejilla

Modelo
GR04

Potencia
recomendada
2x18W=36W

Inner 1
Master 10

Difusor poliestireno



Utiliza 2 tubos
No incluye tubos

Frecuencia	Peso	Material
50-60 Hz	900 gr	Cuerpo ABS, Difusor poliestireno

2400-3000 °K 4100-5700 °K 6500-7000 °K



Luminario de rejilla con tubos

Modelo
GR03

Potencia
2x18W=36W

Flujo
3 200 lm

Inner 1
Master 10

Difusor poliestireno

MULTIVOLTAJE
PROTEGE TUS APARATOS



85-265 V



Utiliza 2 tubos
Incluye tubos T8



Luz fría
6500 K

Frecuencia	Peso	Material
50-60 Hz	1 kg	Cuerpo ABS, Difusor poliestireno



* Las imágenes mostradas en este catálogo son con fines ilustrativos.
IGOTO® se reserva el derecho de modificar la información sin previo aviso y no se hace responsable por omisiones o errores en este documento.



Luminario LED slim de sobreponer

Modelo
LS01 **Modelo**
LS02 **Modelo**
LS03

Potencia
40 W **30 W** **20 W**

Flujo luminoso
3200 lm **2400 lm** **1600 lm**

Peso
387 gr **295 gr** **204 gr**

Inner 1
Master 30

MULTIVOLTAJE
PROTEGE TUS APARATOS



85-265 V



Luz fría
6500 K

Frecuencia
50-60 Hz

Material
Cuerpo aluminio

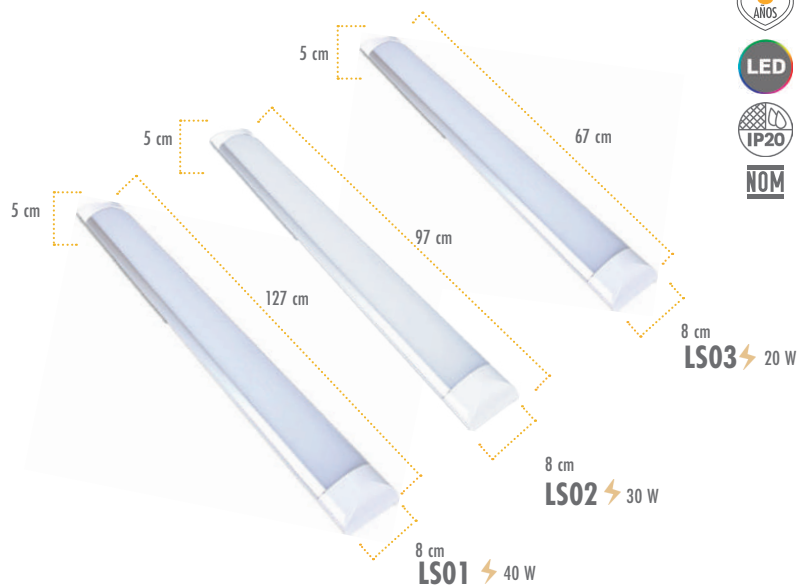

LUMINARIO STREET LIGHT LED

NUEVO



FP > 09
IRC > 70 RA
SUPRESOR DE PICOS > 4 KV



Foto celda



Luz led integrada



Luminario LED STREET LIGHT INDUSTRIAL

LUZ LED INTEGRADA
6 500 °K

Modelo	WATTS	VOLTAJE	HORAS DE VIDA	LUMENS	SUPRESOR DE PICOS	FACTOR DE FRECUENCIA (PF)	INDICE DE REPRODUCCIÓN CRI
SL1050	50	100-277 V	40,000 HRS	5,000	4 K V	≥0.9	70 RA
SL10100	100	100-277 V	40,000 HRS	10,000	4 K V	≥0.9	70 RA
SL10150	150	100-277 V	40,000 HRS	15,000	4 K V	≥0.9	70 RA
SL10200	200	100-277 V	40,000 HRS	20,000	4 K V	≥0.9	70 RA

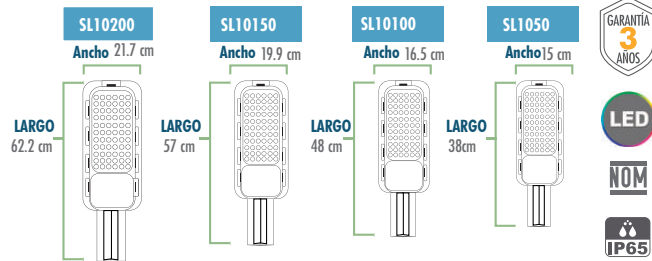

Base de aluminio cubierta de policarbonato



Multivoltaje 100-277 V



40 000 h

Frecuencia 60 Hz

Grado de protección IP 65



NUEVO



LUMINARIO HIGH BAY LED

Luminario LED HIGH BAY INDUSTRIAL

LUZ LED INTEGRADA
6 500 °K

Modelo	WATTS	VOLTAJE	HORAS DE VIDA	LUMENS
U10100	100	100-277 V	30,000 HRS	12,000
U10150	150	100-277 V	30,000 HRS	18,000
U10200	200	100-277 V	30,000 HRS	24,000



FP > 0.95
IRC > 80 RA



Base de aluminio cubierta de policarbonato



Multivoltaje 100-277 V



30 000 h

Frecuencia 60 Hz

Grado de protección IP 65



Luz led integrada

* Las imágenes mostradas en este catálogo son con fines ilustrativos. IGOTO® se reserva el derecho de modificar la información sin previo aviso y no se hace responsable por omisiones o errores en este documento.



REFLECTORES LED

ELIGE EL REFLECTOR IGOTO IDEAL

MARCO PROTECTOR



Mayor protección, mayor durabilidad.



Disponibles en colores: blanco y negro.

Ejemplo con:
Bollinas de 10W

El tipo de lugar y cantidad de las bollinas cambia si lo hacen o actividades según sea mayor distribución de bollinas frente a requerimientos de la visión.



Instalación en exterior
(Ilustración para terraza)



Instalación en interior
(Ilustración para bodega)

PROCESO DE INSTALACIÓN

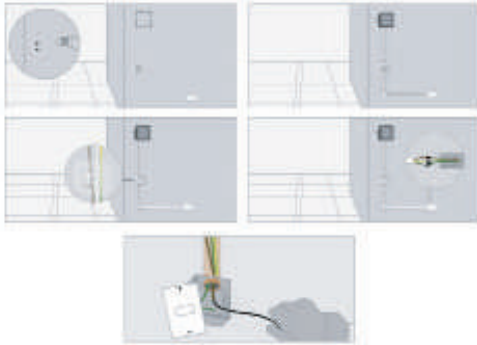

TIPO DE INSTALACIÓN



Pared



Piso



Techo

MÚLTIPLES POSICIONES

FRENTE

COSTADOS



REFLECTORES LED

Modelo	Luz Cálida	Modelo	Luz Fría
REF2010	3 000 °K	REF010	6 500 °K

Reflector LED 10W

Potencia
10 W

Flujo
1 000 lm

Inner 1

Master 60

REFLECTORES LED

LED

IP65

NOM

Fácil instalación

GARANTÍA 2 AÑOS



10.2 cm
8.5 cm
Ancho: 4.5 cm

Cristal templado Marco protector

MULTIVOLTAJE
PROTEGE TUS APARATOS

Conexión por cableado cableado con forro de caucho

110-240 V~ 4 mm FP >0,9 IRC >80

Peso	Tiempo de vida	Lumenes por watts	Resistencia
200 gr	30 000 h	100	IK 07

2400-3000 °K 4100-5700 °K 6500-7000 °K

Modelo	Luz Cálida	Modelo	Luz Fría
REF2020	3 000 °K	REF020	6 500 °K

Reflector LED 20W

Potencia
20 W

Flujo
2 000 lm

Inner 1

Master 40

REFLECTORES LED

LED

IP65

NOM

Fácil instalación

GARANTÍA 2 AÑOS



12.5 cm
10.5 cm
Ancho: 4.5 cm

Cristal templado Marco protector

MULTIVOLTAJE
PROTEGE TUS APARATOS

Conexión por cableado cableado con forro de caucho

110-240 V~ 4 mm FP >0,9 IRC >80

Peso	Tiempo de vida	Lumenes por watts	Resistencia
300 gr	30 000 h	100	IK 07

2400-3000 °K 4100-5700 °K 6500-7000 °K

Modelo	Luz Cálida	Modelo	Luz Fría
REF2030	3 000 °K	REF030	6 500 °K

Reflector LED 30W

Potencia
30 W

Flujo
3 000 lm

Inner 1

Master 40

REFLECTORES LED

LED

IP65

NOM

Fácil instalación

GARANTÍA 2 AÑOS

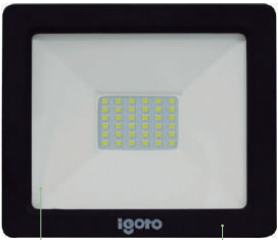

15.5 cm
13.5 cm
Ancho: 5 cm

Cristal templado Marco protector

MULTIVOLTAJE
PROTEGE TUS APARATOS

Conexión por cableado cableado con forro de caucho

110-240 V~ 4 mm FP >0,9 IRC >80

Peso	Tiempo de vida	Lumenes por watts	Resistencia
400 gr	30 000 h	100	IK 07

2400-3000 °K 4100-5700 °K 6500-7000 °K

Modelo	Luz Cálida	Modelo	Luz Fría
REF2050	3 000 °K	REF050	6 500 °K

Reflector LED 50W

Potencia
50 W

Flujo
5 000 lm

Inner 1

Master 20

REFLECTORES LED

LED

IP65

NOM

Fácil instalación

GARANTÍA 2 AÑOS

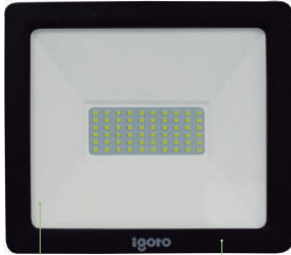

18.5 cm
13 cm
Ancho: 5 cm

Cristal templado Marco protector

MULTIVOLTAJE
PROTEGE TUS APARATOS

Conexión por cableado cableado con forro de caucho

110-240 V~ 4 mm FP >0,9 IRC >80

Peso	Tiempo de vida	Lumenes por watts	Resistencia
700 gr	30 000 h	100	IK 07

2400-3000 °K 4100-5700 °K 6500-7000 °K

* Las imágenes mostradas en este catálogo son con fines ilustrativos. IGOTO® se reserva el derecho de modificar la información sin previo aviso y no se hace responsable por omisiones o errores en este documento.

REFLECTORES LED 

Modelo	Luz Cálida	Modelo	Luz Fría
REF20100	3 000 °K	REF100	6 500 °K

Reflector LED 100W

Potencia
100 W

Flujo
10 000 lm

Inner 1

Master 10



25.5 cm
22.5 cm
Ancho: 5 cm

MULTIVOLTAJE
PROTEGE TUS APARATOS

Conexión por cableado cableado con forro de caucho

110-240 V~ 4 mm FP >0,9 ICR >80

Peso	Tiempo de vida	Lumenes por watts	Resistencia
1.4 kg	30 000 h	100	IK 07

2400-3000 °K 4100-5700 °K 6500-7000 °K

GARANTÍA 2 AÑOS
LED
IP65
NOM
Fácil instalación

Modelo	Luz Fría
REF150	6 500 °K

Reflector LED 150W

Potencia
150 W

Flujo
15 000 lm

Inner 1

Master 5



36.5 cm
32 cm
Ancho: 6 cm

MULTIVOLTAJE
PROTEGE TUS APARATOS

Conexión por cableado cableado con forro de caucho

110-240 V~ 4 mm FP >0,9 ICR >80

Peso	Tiempo de vida	Lumenes por watts	Resistencia
2.9 kg	30 000 h	100	IK 07

GARANTÍA 2 AÑOS
LED
IP65
NOM
Fácil instalación

Modelo	Luz Fría
REF200	6 500 °K

Reflector LED 200W

Potencia
200 W

Flujo
20 000 lm

Inner 1

Master 5



39.5 cm
35 cm
Ancho: 6 cm

Cristal templado

MULTIVOLTAJE
PROTEGE TUS APARATOS

Conexión por cableado

110-240 V~ 4 mm FP >0,9 ICR >80

Peso	Tiempo de vida	Lumenes por watts	Resistencia
3.3 kg	30 000 h	100	IK 07

GARANTÍA 2 AÑOS
LED
IP65
NOM
Fácil instalación

Modelo	Luz Fría
REF300	6 500 °K

Reflector LED 300W

Potencia
300 W

Flujo
30 000 lm

Inner 1

Master 2



39.5 cm
35 cm
Ancho: 6 cm

Cristal templado

MULTIVOLTAJE
PROTEGE TUS APARATOS

Conexión por cableado

110-240 V~ 4 mm FP >0,9 ICR >80

Peso	Tiempo de vida	Lumenes por watts	Resistencia
3.3 kg	30 000 h	100	IK 07

GARANTÍA 2 AÑOS
LED
IP65
NOM
Fácil instalación

REFLECTORES LED

Modelo Luz Fría
REF400 6 500 °K

Reflector LED 400W

Potencia
400 W

Flujo
40 000 lm

Inner 1
Master 2



Cristal templado

GARANTÍA 2 AÑOS

LED EVO

IP65

NOM

Fácil instalación

NUEVO

Modelo Luz Cálida Modelo Luz Fría
REF4010 3000 °K REF3010 6 500 °K

Reflector LED 10W

Potencia
10 W

Flujo
1 000 lm

Inner 1
Master 60



Cristal templado Marco protector

GARANTÍA 2 AÑOS

LED

IP65

NOM

Fácil instalación

Conexión por cableado

110-240 V~ 4 mm FP >0,9 ICR >80

Peso **Tiempo de vida** **Lumenes por watts** **Resistencia**

30 000 h 100 IK 07

Conexión por cableado
cableado con forro de caucho

110-240 V~ 4 mm FP >0,9 ICR >80

Peso **Tiempo de vida** **Lumenes por watts** **Resistencia**

200 gr 30 000 h 100 IK 07

2400-3000 °K 4100-5700 °K 6500-7000 °K

Modelo Luz Cálida Modelo Luz Fría
REF4020 3 000 °K REF3020 6 500 °K

Reflector LED 20W

Potencia
20 W

Flujo
2 000 lm

Inner 1
Master 40



Cristal templado Marco protector

GARANTÍA 2 AÑOS

LED

IP65

NOM

Fácil instalación

NUEVO

Modelo Luz Cálida Modelo Luz Fría
REF4030 3 000 °K REF3030 6 500 °K

Reflector LED 30W

Potencia
30 W

Flujo
3 000 lm

Inner 1
Master 40



Cristal templado Marco protector

GARANTÍA 2 AÑOS

LED

IP65

NOM

Fácil instalación

MULTIVOLTAJE
PROTEGE TUS APARATOS

Conexión por cableado
cableado con forro de caucho

110-240 V~ 4 mm FP >0,9 ICR >80

Peso **Tiempo de vida** **Lumenes por watts** **Resistencia**

300 gr 30 000 h 100 IK 07

2400-3000 °K 4100-5700 °K 6500-7000 °K

MULTIVOLTAJE
PROTEGE TUS APARATOS

Conexión por cableado
cableado con forro de caucho

110-240 V~ 4 mm FP >0,9 ICR >80

Peso **Tiempo de vida** **Lumenes por watts** **Resistencia**

400 gr 30 000 h 100 IK 07

2400-3000 °K 4100-5700 °K 6500-7000 °K

* Las imágenes mostradas en este catálogo son con fines ilustrativos. IGOTO® se reserva el derecho de modificar la información sin previo aviso y no se hace responsable por omisiones o errores en este documento.



REFLECTORES LED

Modelo	Luz Cálida	Modelo	Luz Fría
REF4050	3 000 °K	REF3050	6 500 °K

Reflector LED 50W

Potencia
50 W

Flujo
5 000 lm

Inner 1

Master 20



18.5 cm
13 cm
Ancho: 5 cm

Cristal templado Marco protector

MULTIVOLTAJE
PROTEGE TUS APARATOS

Conexión por cableado
cableado con forro de caucho

110-240 V~ 4 mm FP >0,9 IRC >80

Peso	Tiempo de vida	Lumenes por watts	Resistencia
700 gr	30 000 h	100	IK 07

2400-3000 °K 4100-5700 °K 6500-7000 °K

Modelo	Luz Cálida	Modelo	Luz Fría
REF40100	3 000 °K	REF30100	6 500 °K

Reflector LED 100W

Potencia
100 W

Flujo
10 000 lm

Inner 1

Master 10



25.5 cm
22.5 cm
Ancho: 5 cm

Cristal templado

MULTIVOLTAJE
PROTEGE TUS APARATOS

Conexión por cableado
cableado con forro de caucho

110-240 V~ 4 mm FP >0,9 IRC >80

Peso	Tiempo de vida	Lumenes por watts	Resistencia
1.4 kg	30 000 h	100	IK 07

2400-3000 °K 4100-5700 °K 6500-7000 °K

Modelo	Luz Fría
REF30150	6 500 °K

Reflector LED 150W

Potencia
150 W

Flujo
15 000 lm

Inner 1

Master 5



36.5 cm
32 cm
Ancho: 6 cm

Cristal templado

MULTIVOLTAJE
PROTEGE TUS APARATOS

Conexión por cableado
cableado con forro de caucho

110-240 V~ 4 mm FP >0,9 IRC >80

Peso	Tiempo de vida	Lumenes por watts	Resistencia
2.9 kg	30 000 h	100	IK 07

Modelo	Luz Fría
REF30200	6 500 °K

Reflector LED 200W

Potencia
200 W

Flujo
20 000 lm

Inner 1

Master 5



39.5 cm
35 cm
Ancho: 6 cm

Cristal templado

MULTIVOLTAJE
PROTEGE TUS APARATOS

Conexión por cableado
cableado con forro de caucho

110-240 V~ 4 mm FP >0,9 IRC >80

Peso	Tiempo de vida	Lumenes por watts	Resistencia
3.3 kg	30 000 h	100	IK 07

* Las imágenes mostradas en este catálogo son con fines ilustrativos. IGOTO® se reserva el derecho de modificar la información sin previo aviso y no se hace responsable por omisiones o errores en este documento.

igoto
SWISS®

NUEVO

VENTILADOR 3 EN 1

45,7 CM

18"



▶ VENTILADORE 3 EN 1

Ventilador 3 en 1 18"

Modelo
VP1003, 4P1003

Inner -
Master 1



ASPAS Y CUERPO
DE METAL

Diametro: 45,7 cm / 18"
Peso: 2,55 kg

NUEVO

PEDESTAL



45,7cm
18"

PARED



CAJA 1 INDIVIDUAL
VP1003

PISO



CAJA 4 PACK
4P1003

GARANTIA
3
AÑOS



NOM



Control de
velocidades



127 V ~



Velocidad
Ajustable



Distribución de
aire fija o giratoria

Potencia del motor
60 W

Frecuencia
60 Hz

Peso del motor
2,55 kg

Material
Aspas metálicas

3
ASPAS DE
METAL

3
VELOCIDADES

* Las imágenes mostradas en este catálogo son con fines ilustrativos.
IGOTO® se reserva el derecho de modificar la información sin previo aviso y no se hace responsable por omisiones o errores en este documento.





igoto
SWISS®

VENTILADOR INDUSTRIAL 1,4 M **56"**

ELIGE EL VENTILADOR **IGOTO** IDEAL

MEDIDAS RECOMENDADAS

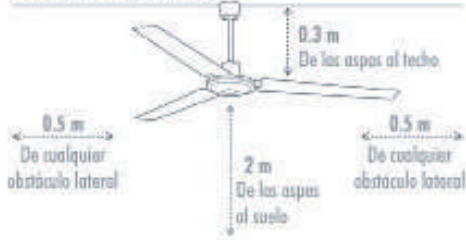

 Incluye gancho para instalación

 Motor reforzado — Mayor durabilidad

Nuestros ventiladores iGoto están protegidos contra:



	CUARTO PEQUEÑO	CUARTO MEDIANO	CUARTO GRANDE
TAMAÑO DEL ESPACIO	9m ² o menos	37m ² o menos	37m ² o más
TAMAÑO DEL VENTILADOR	30"	42"	56"
TIPO DE DEL ESPACIO	 Recámara  Lavandería  Walk in closet	 Oficina  Cocina	 Sala  Recámara grande  Patio grande

VENTILADORES

Ventilador Industrial BLANCO de 56"

Modelo
V5601

Inner -
Master 1

3 ASPAS



Nivel de desplazamiento de aire



ALTO
10 000 m³/h



MOTOR
REFORZADO



110-127 V~



Control de velocidad
de pared



300 RPM
5 velocidades



Aspas: 56 cm

Diametro: 142 cm
Peso: 5 kg aprox.

Potencia del motor
70 W

Frecuencia
60 Hz

Peso del motor
2,55 kg

Material
Aspas metálicas

3 PACK Ventilador Industrial BLANCO de 56"

Modelo
V56-70w

Inner -
Master 3

3 ASPAS

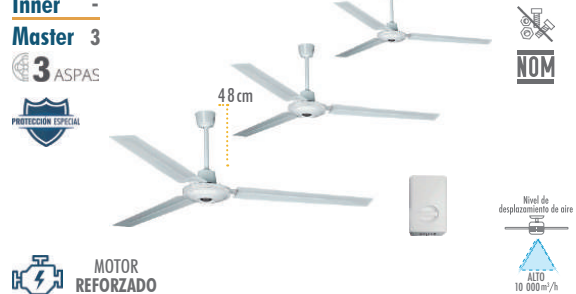

Nivel de desplazamiento de aire



ALTO
10 000 m³/h



MOTOR
REFORZADO



110-127 V~



Control de velocidad
de pared



300 RPM
5 velocidades



Aspas: 56 cm

Diametro: 142 cm
Peso: 5 kg aprox.

Potencia del motor
70 W

Frecuencia
60 Hz

Peso del motor
2,55 kg

Material
Aspas metálicas

VENTILADORES

Ventilador Industrial NEGRO de 56"

Modelo
V5602

Inner -
Master 1

3 ASPAS



Nivel de desplazamiento de aire



ALTO
10 000 m³/h



MOTOR
REFORZADO



Silencioso



110-127 V~



Control de velocidad
de pared



300 RPM
5 velocidades



Aspas: 56 cm

Diametro: 142 cm
Peso: 5 kg aprox.

Potencia del motor
70 W

Frecuencia
60 Hz

Peso del motor
2,8 kg

Material
Aspas metálicas

3 PACK Ventilador Industrial NEGRO de 56"

Modelo
3VP5602

Inner -
Master 3

3 ASPAS



Nivel de desplazamiento de aire



ALTO
10 000 m³/h



MOTOR
REFORZADO



Silencioso



110-127 V~



Control de velocidad
de pared



300 RPM
5 velocidades

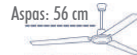

Aspas: 56 cm

Diametro: 142 cm
Peso: 5 kg aprox.

Potencia del motor
70 W

Frecuencia
60 Hz

Peso del motor
2,8 kg

Material
Aspas metálicas

* Las imágenes mostradas en este catálogo son con fines ilustrativos.
IGOTO® se reserva el derecho de modificar la información sin previo aviso y no se hace responsable por omisiones o errores en este documento.



VENTILADORES DECORATIVOS



VENTILADORES DECORATIVOS

NUEVO

Ventilador BIENA 52"

Modelo V5201

Inner - Master 1

3 ASPAS
PROTECCIÓN ESPECIAL



GARANTÍA 3 AÑOS



DC
Motor DC

- MAYOR EFICIENCIA
- MENOR CONSUMO
- MAYOR RENDIMIENTO
- SILENCIOSO
- LIGERO

Motor DC
35 W
EQUIVALE A 70 W AC

Control remoto

Luz led integrada 18 W

Nivel de desplazamiento de aire
LIGERO
4 500 m³/h

LUZ LED 3000 K INTEGRADA 4500K 18 W 6000K

100-240 V ~
MULTIVOLTIAJE

Silencioso

6 VELOCIDADES

3 ASPAS DE MADERA

Diametro: 132 cm
Peso: 7.5 kg aprox.

Potencia del motor
DC 35 W

Frecuencia
60 Hz

Material
3 ASPAS DE MADERA
LIGERAS Y RESISTENTES

NUEVO

Ventilador BIENA 52"

Modelo V5202

Inner - Master 1

3 ASPAS
PROTECCIÓN ESPECIAL



GARANTÍA 3 AÑOS



DC
Motor DC

- MAYOR EFICIENCIA
- MENOR CONSUMO
- MAYOR RENDIMIENTO
- SILENCIOSO
- LIGERO

Motor DC
35 W
EQUIVALE A 70 W AC

Control remoto

Luz led integrada 18 W

Nivel de desplazamiento de aire
MODERADO
7 000 m³/h

LUZ LED 3000 K INTEGRADA 4500K 18 W 6000K

100-240 V ~
MULTIVOLTIAJE

Silencioso

6 VELOCIDADES

3 ASPAS DE MADERA

Diametro: 132 cm
Peso: 7.5 kg aprox.

Potencia del motor
DC 35 W

Frecuencia
60 Hz

Material
3 ASPAS DE MADERA
LIGERAS Y RESISTENTES



CATÁLOGO 2024 | 79

* Las imágenes mostradas en este catálogo son con fines ilustrativos. IGOTO® se reserva el derecho de modificar la información sin previo aviso y no se hace responsable por omisiones o errores en este documento.

VENTILADORES DECORATIVOS

NUEVO

Ventilador BIENA 52"

Modelo V5203

Inner - Master 1

3 ASPAS



Motor DC

- MAYOR EFICIENCIA
- MENOR CONSUMO
- MAYOR RENDIMIENTO
- SIENCIOSO
- LIGERO



Motor DC
35 W
EQUIVALE A 70 W AC



Control remoto



Luz led
integrada 18 W



Nivel de desplazamiento de aire
LIGERO 4.500 m³/h

LUZ LED 3000 K

INTEGRADA 4500K

18 W 6000K



100-240 V~
MULTIVOLTAJE



Silencioso



6 VELOCIDADES



3 ASPAS DE MADERA

Potencia del motor
DC 35 W

Frecuencia
60 Hz

Material
3 ASPAS DE MADERA
LIGERAS Y RESISTENTES



Diametro: 132 cm
Peso: 7.5 kg aprox.

NUEVO

Ventilador VERNIER 52"

Modelo V5204

Inner - Master 1

4 ASPAS



Motor DC

- MAYOR EFICIENCIA
- MENOR CONSUMO
- MAYOR RENDIMIENTO
- SIENCIOSO
- LIGERO



Motor DC
35 W
EQUIVALE A 70 W AC



Control remoto



Luz led
integrada 18 W



Nivel de desplazamiento de aire
LIGERO 4.500 m³/h

LUZ LED 3000 K

INTEGRADA 4500K

18 W 6000K



100-240 V~
MULTIVOLTAJE



Silencioso



6 VELOCIDADES



3 ASPAS DE MADERA

Potencia del motor
DC 35 W

Frecuencia
60 Hz

Material
4 ASPAS DE MADERA COLOR MAPLE
OSCURO Y BASE NEGRA



Diametro: 132 cm
Peso: 7.5 kg aprox.

NUEVO

Ventilador VERNIER 52"

Modelo V5205

Inner - Master 1

4 ASPAS



Motor DC

- MAYOR EFICIENCIA
- MENOR CONSUMO
- MAYOR RENDIMIENTO
- SIENCIOSO
- LIGERO



Motor DC
35 W
EQUIVALE A 70 W AC



Control remoto



Luz led
integrada 18 W



Nivel de desplazamiento de aire
LIGERO 4.500 m³/h

LUZ LED 3000 K

INTEGRADA 4500K

18 W 6000K



100-240 V~
MULTIVOLTAJE



Silencioso



6 VELOCIDADES



3 ASPAS DE MADERA

Potencia del motor
DC 35 W

Frecuencia
60 Hz

Material
4 ASPAS DE MADERA COLOR MAPLE
OSCURO Y BASE NEGRA



Diametro: 132 cm
Peso: 7.5 kg aprox.

NUEVO

Ventilador LUCERNA 42"

Modelo V4209

Inner - Master 1

3 ASPAS



Motor DC

- MAYOR EFICIENCIA
- MENOR CONSUMO
- MAYOR RENDIMIENTO
- SIENCIOSO
- LIGERO



Motor DC
32 W
EQUIVALE A 65 W AC



Control remoto



Luz led
integrada 36 W



Nivel de desplazamiento de aire
LIGERO 4.500 m³/h

LUZ LED 3000 K

INTEGRADA 4500K

18 W 6000K



100-240 V~
MULTIVOLTAJE



Silencioso



6 VELOCIDADES



3 ASPAS DE MADERA

Potencia del motor
DC 32 W

Frecuencia
60 Hz

Material
3 ASPAS RETRACTILES DE ACRILICO
BASE NEGRA Y ASPAS MARRÓN



Diametro: 106 cm
Peso: 8.4 kg aprox.

* Las imágenes mostradas en este catálogo son con fines ilustrativos.
IGOTO® se reserva el derecho de modificar la información sin previo aviso y no se hace responsable por omisiones o errores en este documento.



VENTILADORES DECORATIVOS

NUEVO

Ventilador LUCERNA 42"

Modelo V4210

Inner - Master 1

3 ASPAS

3 ASPAS RETRACTILES DE ACRILICO

Motor DC

- MAYOR EFICIENCIA
- MENOR CONSUMO
- MAYOR RENDIMIENTO
- SIENCIOSO
- LIGERO

Motor DC 32 W
EQUIVALE A 65 W AC

Control remoto

Luz led integrada 36 W

LUZ LED 3000 K INTEGRADA 4500K 18 W 6000K

100-240 V~ MULTIVOLTAJE Silencioso 6 VELOCIDADES 3 ASPAS DE ACRILICO

Potencia del motor DC 32 W | **Frecuencia** 60 Hz | **Material** 3 ASPAS RETRACTILES DE ACRILICO BASE BLANCA Y ASPAS TRANSPARENTES

Garantía 3 años, NOM, Motor Reforzado, Nivel de desplazamiento de aire ligero 4500 m³/h, Diámetro: 106 cm, Peso: 8.4 kg aprox.

NUEVO

Ventilador LUCERNA 42"

Modelo V4211

Inner - Master 1

3 ASPAS

3 ASPAS RETRACTILES DE ACRILICO

Motor DC

- MAYOR EFICIENCIA
- MENOR CONSUMO
- MAYOR RENDIMIENTO
- SIENCIOSO
- LIGERO

Motor DC 32 W
EQUIVALE A 65 W AC

Control remoto

Luz led integrada 36 W

LUZ LED 3000 K INTEGRADA 4500K 18 W 6000K

100-240 V~ MULTIVOLTAJE Silencioso 6 VELOCIDADES 3 ASPAS DE ACRILICO

Potencia del motor DC 32 W | **Frecuencia** 60 Hz | **Material** 3 ASPAS RETRACTILES DE ACRILICO BASE BLANCA Y ASPAS TRANSPARENTES

Garantía 3 años, NOM, Motor Reforzado, Nivel de desplazamiento de aire ligero 4500 m³/h, Diámetro: 106 cm, Peso: 8.4 kg aprox.

Ventilador Aria 42"

Modelo V4201

Inner - Master 1

5 ASPAS

23 cm

CONTROL POR CADENA

MOTOR REFORZADO

Aspas: 41 cm

LUZ Aire

Nivel de desplazamiento de aire MODERADO 7000 m³/h

110-127 V~ 3 FOCOS No incluye focos 110/160/200 3 velocidades

Diametro: 106cm Peso: 5 kg aprox.

Potencia del motor 60 W | **Frecuencia** 60 Hz | **Base** E26 | **Material** Niquel cromado aspas negras

Garantía 3 años, NOM, Motor Reforzado, Nivel de desplazamiento de aire moderado 7000 m³/h, Aspas: 41 cm, Diámetro: 106 cm, Peso: 5 kg aprox.

Ventilador Aria 42"

Modelo V4202

Inner - Master 1

5 ASPAS

23 cm

CONTROL POR CADENA

MOTOR REFORZADO

Aspas: 41 cm

LUZ Aire

Nivel de desplazamiento de aire MODERADO 7000 m³/h

110-127 V~ 3 FOCOS No incluye focos 110/160/200 3 velocidades

Diametro: 106cm Peso: 5 kg aprox.

Potencia del motor 60 W | **Frecuencia** 60 Hz | **Base** E26 | **Material** Niquel cromado aspas madera

Garantía 3 años, NOM, Motor Reforzado, Nivel de desplazamiento de aire moderado 7000 m³/h, Aspas: 41 cm, Diámetro: 106 cm, Peso: 5 kg aprox.

VENTILADORES

Ventilador Ventum 30"

Modelo
V3001

Inner -

Master 1

6 ASPAS



CONTROL POR
CADENA

MOTOR
REFORZADO

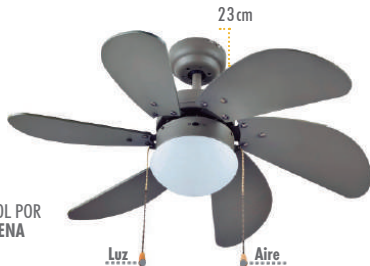

GARANTÍA
3
AÑOS



NOM

Nivel de
desplazamiento de aire



Aspas: 32cm

110-127 V~

1 FOCO
No incluye foco

110/160/230
3 velocidades

Diametro: 76 cm
Peso: 5 kg aprox.

Potencia del motor	Frecuencia	Base	Material
60 W	60 Hz	E27	Aspas de madera gris titano

Ventilador Ventum 30"

Modelo
V3002

Inner -

Master 1

6 ASPAS



CONTROL POR
CADENA

MOTOR
REFORZADO

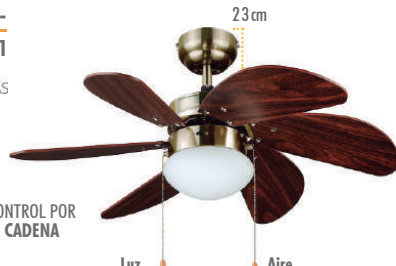

GARANTÍA
3
AÑOS



NOM

Nivel de
desplazamiento de aire



Aspas: 32cm

110-127 V~

1 FOCO
No incluye foco

110/160/230
3 velocidades

Diametro: 76 cm
Peso: 5 kg aprox.

Potencia del motor	Frecuencia	Base	Material
60 W	60 Hz	E26	Latón antiguo aspas madera

Ventilador Brezza 42"

Modelo
V4203

Inner -

Master 1

4 ASPAS



CONTROL POR
CADENA

MOTOR
REFORZADO

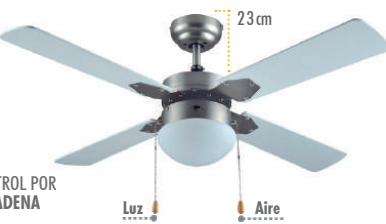

GARANTÍA
3
AÑOS



NOM

Nivel de
desplazamiento de aire



Aspas: 41cm

110-127 V~

1 FOCO
No incluye foco

110/160/210
3 velocidades

Diametro: 106cm
Peso: 5 kg aprox.

Potencia del motor	Frecuencia	Base	Material
60 W	60 Hz	E26	Niquel brillante aspas blancas

Ventilador Brezza 42"

Modelo
V4204

Inner -

Master 1

4 ASPAS



CONTROL POR
CADENA

MOTOR
REFORZADO



GARANTÍA
3
AÑOS



NOM

Nivel de
desplazamiento de aire



Aspas: 41cm

110-127 V~

1 FOCO
No incluye foco

110/160/210
3 velocidades

Diametro: 106cm
Peso: 5 kg aprox.

Potencia del motor	Frecuencia	Base	Material
60 W	60 Hz	E26	Niquel cromado aspas gris

* Las imágenes mostradas en este catálogo son con fines ilustrativos.
IGOTO® se reserva el derecho de modificar la información sin previo aviso y no se hace responsable por omisiones o errores en este documento.



VENTILADORES



Ventilador Vant 42"

Modelo
V4205

Inner -
Master 1

4 ASPAS



110-127 V~

1 FOCO
No incluye foco

105/160/210
3 velocidades

Aspas: 41 cm
Diametro: 106 cm
Peso: 5 kg aprox.

Potencia del motor	Frecuencia	Base	Material
60 W	60 Hz	E26	Níquel brillante aspas negras

Ventilador Vant 42"

Modelo
V4206

Inner -
Master 1

4 ASPAS

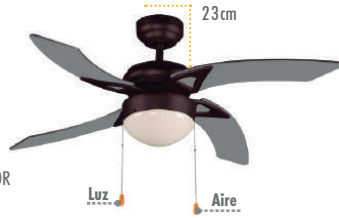

110-127 V~

1 FOCO
No incluye foco

105/160/210
3 velocidades

Aspas: 41 cm
Diametro: 106 cm
Peso: 5 kg aprox.

Potencia del motor	Frecuencia	Base	Material
60 W	60 Hz	E26	Negro y aspas gris

NUEVO

Ventilador Ventall 42"

Modelo
V4207

Inner -
Master 1

4 ASPAS



110-127 V~

1 FOCO
No incluye foco

110/160/230
3 velocidades

Aspas: 41 cm
Diametro: 106 cm
Peso: 5 kg aprox.

Potencia del motor	Frecuencia	Base	Material
60 W	60 Hz	E26	Blanco y aspas blancas

NUEVO

Ventilador Ventall 42"

Modelo
V4208

Inner -
Master 1

4 ASPAS

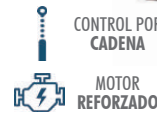
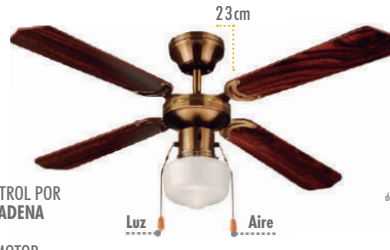

110-127 V~

1 FOCO
No incluye foco

110/160/230
3 velocidades

Aspas: 41 cm
Diametro: 106 cm
Peso: 5 kg aprox.

Potencia del motor	Frecuencia	Base	Material
60 W	60 Hz	E26	Latón antiguo aspas madera



iGoto
SWISS[®]



igoto[®]

PUMPS

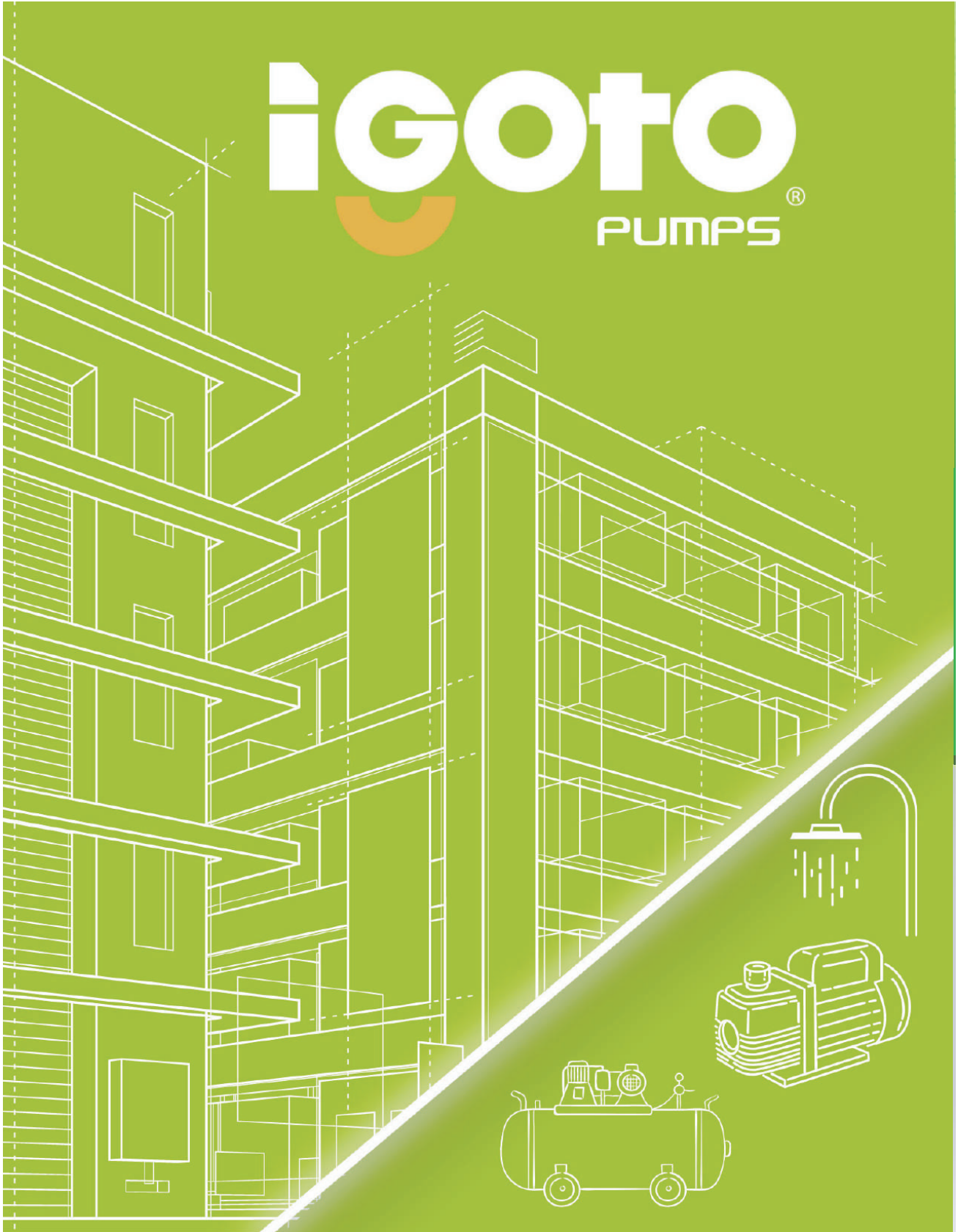

igoto

PUMPS



BOMBA PRESURIZADOR

¡Disfruta de un buen baño!
Aumenta la presión del agua con nuestros presurizadores.

BOMBA PERIFÉRICA

¡Lleva el agua a donde tú quieras!
Máxima presión en edificios e instalaciones altas.

BOMBA CENTRÍFUGA

¿Necesitas más agua?
Obtén grandes cantidades con nuestras bombas centrífugas.

SOLDADORA MINI Y PLUS

Ideal para trabajo industrial ligero.

BOMBA TIPO BALA

Obten agua desde lugares profundos.

BOMBA SUMERGIBLE

Presión constante desde la cisterna a tu hogar

AMARRA CON
INJERTO DE BRONCE



MAYOR POTENCIA



EMBOBINADO DE COBRE

MEJOR CONDUCCIÓN Y MENOS CALENTAMIENTO

IMPULSOR DE BRONCE

MAYOR DURABILIDAD Y FLUJO CONSTANTE





LLEVANDO EL
PODER
DEL AGUA AL MÁXIMO

PRODUCTOS NUEVOS

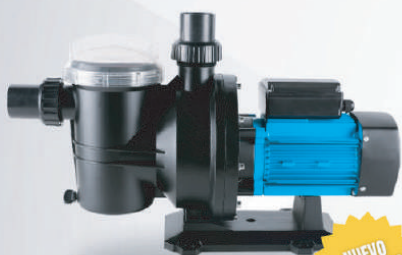

BP-1

BP-1.5

BP-2

PAG. 95

NUEVO PRODUCTO



PRO-24

PRO-50

PAG. 104

NUEVO PRODUCTO



QDA-370

QDA-550

QDA-750

PAG. 99

NUEVO PRODUCTO



P-135 MIG

PAG. 106

NUEVO PRODUCTO



PAC-200

PAG. 98

NUEVO PRODUCTO



PAC-100

PAG. 98

NUEVO PRODUCTO



PAC-15

PAG. 98

NUEVO PRODUCTO

BOMBA DE PRESIÓN CONSTANTE



LLEVANDO EL **PODER** DEL AGUA AL MÁXIMO

BOMBA DE AGUA DE PRESIÓN CONSTANTE

- SOporta ALTAS TEMPERATURAS
- HASTA **10** SERVICIOS
- PRESIÓN CONSTANTE Y SIMULTÁNEA
- SILENCIOSO

Bomba de presión constante

Altura Máxima hasta 45 m



APLICACIONES:



VENTAJAS:

IDEAL PARA VACIAR O BOMBEAR GRANDES CANTIDADES DE AGUA

- 1- Soporta altas temperaturas
- 2- Hasta 10 servicios
- 3- Presión constante y simultánea en todos los servicios
- 3- Silenciosa



MODELO	Potencia HP	W	Voltaje	A. Max (m)	A. Max (l/m)	Descarga	Decibeles	Servicios	Grado IP
APF200	0,75	550	127 V ~	45	83	25 mm 1" FNPT	42 dB	10 servicios aprox	55

* Las imágenes mostradas en este catálogo son con fines ilustrativos. IGOTO® se reserva el derecho de modificar la información sin previo aviso y no se hace responsable por omisiones o errores en este documento.

BOMBAS PERIFÉRICAS



Bomba Periférica

Altura Máxima hasta 60 m

MAYOR FLUJO DE AGUA



APLICACIONES:



VENTAJAS:

MÁXIMA PRESIÓN DE AGUA A GRANDES ALTURAS

- 1- Mejor conducción y menos calentamiento
- 2- Mayor durabilidad y flujo constante
- 3- Evita que la bomba se pegue y mantiene su alto rendimiento

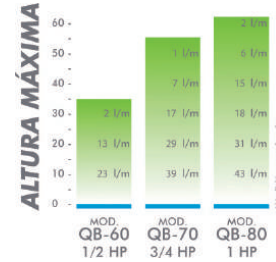

EMBOBINADO DE **COBRE**
MEJOR CONDUCCIÓN Y MENOS CALENTAMIENTO

IMPULSOR DE BRONCE
MAYOR DURABILIDAD, FLUJO CONSTANTE



IDEAL PARA **TANQUE HIDRONEUMÁTICO**

MODELO	Potencia HP	W	Motor	A. Max (m)	C. Max (l/m)	Conexiones Succ.	Des.	Capacitor	Corriente Eléctrica	Peso
QB-60	1/2	370	1 F 127 V~	35	35	1"	1"	20 µF	3.5 A	5.5 kg
QB-70	3/4	550	1 F 127 V~	55	55	1"	1"	30 µF	7.2 A	8.8 kg
QB-80	1	750	1 F 127 V~	60	60	1"	1"	40 µF	11 A	9 kg

Bomba Periférica DUO

Altura Máxima hasta 60 m



APLICACIONES:



VENTAJAS:

MAYOR FLUJO DE AGUA

- 1- Embobinado con protección térmica
- 2- Mayor durabilidad y flujo constante
- 3- Evita que la bomba se pegue y mantiene su alto rendimiento

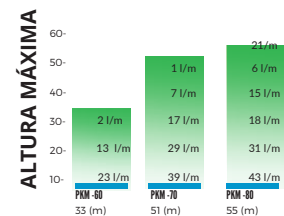
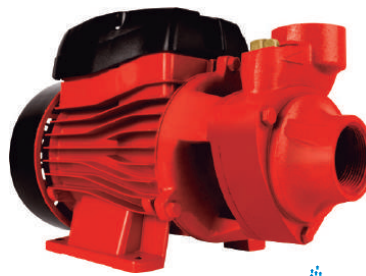

Embobinado con **PROTECCIÓN TÉRMICA**

IMPULSOR DE BRONCE
MAYOR DURABILIDAD, FLUJO CONSTANTE



IDEAL PARA **TANQUE HIDRONEUMÁTICO**

INCERTO DE BRONCE

MODELO	Potencia HP	W	Motor	A. Max (m)	C. Max (l/m)	Conexiones Succ.	Des.	Capacitor	Corriente Eléctrica	Peso
PKM-60	1/2	370	1 F 127 V~	33	31	1"	1"	20 µF	3.5 A	3.5 kg
PKM-70	3/4	550	1 F 127 V~	51	43	1"	1"	30 µF	7.2 A	7.5 kg
PKM-80	1	750	1 F 127 V~	55	48	1"	1"	40 µF	11 A	8 kg



BOMBAS PERIFÉRICAS

Bomba Periférica NOVA

Altura Máxima hasta 24 m

NOVA



APLICACIONES:



Doméstico



Agrícola



Aspersores



Llenado de tinaco



Llenado de alberca

VENTAJAS:

MAYOR FLUJO DE AGUA

- 1- Embobinado con protección térmica
- 2- Mayor durabilidad y flujo constante
- 3- Bajo consumo de energía

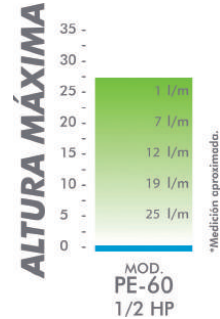

IMPULSOR DE BRONCE
MAYOR DURABILIDAD.
FLUJO CONSTANTE



Embobinado
con PROTECCIÓN
TÉRMICA

MODELO	Potencia HP	Potencia W	Motor	A. Max (m)	C. Max (l/m)	Conexiones Succ.	Conexiones Des.	Capacitor	Corriente Eléctrica	Peso
PE-60	1/2	370	1 F 127 V~	24	32	1"	1"	20 µF	3.5 A	3.5 kg

Bomba Autocebante

Altura Máxima hasta 45 m

MAYOR FLUJO DE AGUA



APLICACIONES:



Doméstico



Agrícola



Aspersores



Llenado de tinaco



Llenado de alberca

VENTAJAS:

IDEAL PARA BOMBEO Y ASPIRACIÓN SIN MAYOR MANTENIMIENTO

- 1- Mejor conducción y menos calentamiento
- 2- Mayor durabilidad y flujo constante

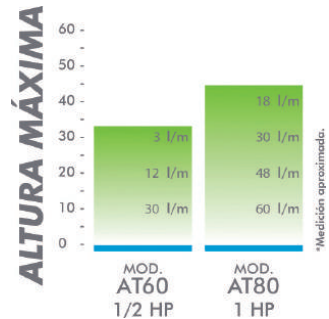

IMPULSOR DE BRONCE
MAYOR DURABILIDAD.
FLUJO CONSTANTE



MODELO	Potencia HP	Potencia W	Motor	A. Max (m)	C. Max (l/m)	Conexiones Succ.	Conexiones Des.	Capacitor	Corriente Eléctrica	Peso
AT60	1/2	370	1 F 127 V~	33	30	1"	1"	25 µF	5.2 A	7.5 kg
AT80	1	750	1 F 127 V~	45	50	1"	1"	35 µF	10.8 A	10.8 kg

* Las imágenes mostradas en este catálogo son con fines ilustrativos.
IGOTO® se reserva el derecho de modificar la información sin previo aviso y no se hace responsable por omisiones o errores en este documento.



BOMBAS CENTRÍFUGAS

Bomba JET

APLICACIONES:



VENTAJAS: MÁXIMO CAUDAL Y PRESIÓN EN UN SOLO PRODUCTO

- 1- Mayor durabilidad
- 2- Flujo constante
- 3- Bajo consumo de energía.

Altura Máxima hasta 52 m

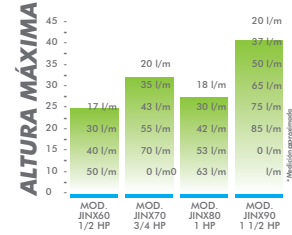

CABEZAL y FLECHA DE ACERO INOXIDABLE MAYOR DURABILIDAD

Hasta 60 C° TEMPERATURA

IMPULSOR DE PLÁSTICO FLUJO CONSTANTE

ALTO DESEMPEÑO

MODELO	Potencia HP	Potencia W	Motor	A. Max (m)	Rango operación H(m)	Conexiones Succ. Des.	Capacitor	Corriente Eléctrica	Peso
JINX60	1/2	370	1 F 127 V~	38	8-27	41-5 1" 1"	30 µF	4.7 A	7.4 kg
JINX70	3/4	550	1 F 127 V~	40	10-32	44-5 1" 1"	40 µF	8.7 A	7.8 kg
JINX80	1	750	1 F 127 V~	44	10-36	48-5 1" 1"	50 µF	9.5 A	8.5 kg
JINX90	1 1/2	1100	1 F 127 V~	52	10-40	51-5 1" 1"	50 µF	11 A	9.2 kg

Bomba Multietapa

APLICACIONES:



VENTAJAS: ABASTECIMIENTO DE AGUA A GRANDES ALTURAS

- 1- Máximo ahorro de energía
- 2- Mayor durabilidad y flujo constante
- 3- Silencioso y fácil instalación

Altura Máxima hasta 50 m

NUEVO



FLECHA DE ACERO INOXIDABLE MAYOR DURABILIDAD

IMPULSOR DE PLÁSTICO FLUJO CONSTANTE

MODELO	Potencia HP	Potencia W	Motor	A. Max (m)	C. Max (l/m)	Conexiones Succ. Des.	Capacitor	Corriente Eléctrica
MH550	0.5	370	1 F 120 V ~	34	80	1" 1"	40 µF	6 A
MH900	0.75	550	1 F 120 V ~	50	90	1" 1"	55 µF	8.5 A
MH1500	1	750	1 F 120 V ~	35	130	1" 1"	70 µF	12 A
MH1800	1.5	1100	1 F 120 V ~	50	130	1" 1"	100 µF	15.5 A



BOMBAS CENTRÍFUGAS

Bomba Centrífuga DUO

Altura Máxima hasta 32 m

DUO



APLICACIONES:



Doméstico



Agrícola



Aspersores



Llenado de tinaco



Llenado de alberca

VENTAJAS:

MÁXIMO CAUDAL A GRANDES ALTURAS

1- Embobinado con protección térmica

2- Mayor durabilidad y flujo constante

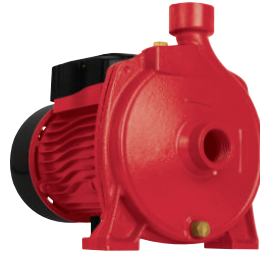

Embobinado con PROTECCIÓN TÉRMICA

IMPULSOR DE BRONCE
MAYOR DURABILIDAD, FLUJO CONSTANTE

ALTURA MÁXIMA

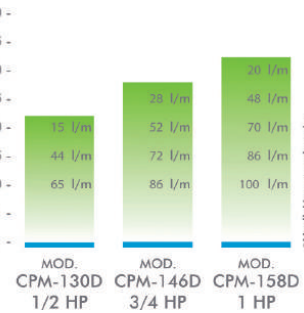

MODELO	Potencia HP	W	Motor	A. Max (m)	Rango operación H(m) Q(l/m)		Conexiones Succ. Des.	Capacitor	Corriente Eléctrica	Peso
CPM-130D	1/2	370	1 F 127 V~	22	20-6	18-80	1" 1"	25 µF	4.5 A	9.2 kg
CPM-146D	3/4	550	1 F 127 V~	28	26-8	23-92	1" 1"	35 µF	7.2 A	12 kg
CPM-158D	1	750	1 F 127 V~	32	30-10	18-100	1" 1"	45 µF	9.8 A	13 kg

Bomba para fuentes*

Altura Máxima hasta 8 m



APLICACIONES:



Circulación del agua



Fuentes



Comercial



Doméstico



Drenaje

VENTAJAS:

FUNCIONAMIENTO EFICAZ Y CONSTANTE

1- Motor con polos protegidos contra sobrecarga

2- Graduación de la temperatura del líquido

3- Pantalla de entrada extraíble para mejor limpieza



ALTURA MÁXIMA

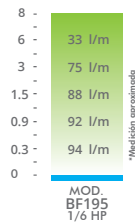

MODELO	Potencia HP	HZ	Motor	PSI	A. Max (m)	C. Max (l/m)	Ampers FLA	Ampers del disyuntor	Peso
BF195	1/6	60	115 V~	11.4	6	76	2.0	15 A	3.4 kg

* Las imágenes mostradas en este catálogo son con fines ilustrativos. IGOTO® se reserva el derecho de modificar la información sin previo aviso y no se hace responsable por omisiones o errores en este documento.



Bomba para piscina

APLICACIONES:



Doméstico



Agrícola



Aspersores



Llenado de tinaco



Llenado de alberca

VENTAJAS:

PRESIÓN CONSTANTE A MÁXIMA ALTURA

1- SILENCIOSA

2- PRESION CONSTANTE

NUEVO

Altura Máxima hasta 16 m

NUEVO

ALTO DESEMPEÑO



Potencia



Presión Constante



MULTIVOLTAJE
110 / 220 V



ENTRADA Y SALIDA
2" X 2" NPT



CICLO DE TRABAJO
6 A 8 hrs

MODELO	Potencia HP	W	A. Max (m)	Volumen filtrado	Peso	Caudal Máximo
BP- 1	1	325	12m	80	11	325 l/m
BP- 1.5	1.5	360	15m	110	12.2	360 l/m
BP- 2	2	450	16m	135	15.7	350 l/m

TANQUES HIDRONEUMÁTICOS

Tanque Hidroneumático

MÁXIMA PRESIÓN EN TODAS LAS SALIDAS DE AGUA.

IDEAL PARA BOMBAS:

PKM-60 QB-60 QB-70 QB-80



Almacenaje de agua



Mantenimiento continuo

INCLUYE:

1- Manómetro

1- Conector

1- Automático

1- Manguera Flexible



INCLUYE KIT:



MANÓMETRO



CONECTOR



AUTOMÁTICO



MANGUERA FLEXIBLE

MODELO	Capacidad real	Conexión	Presión máxima	Peso
TH-24	21 L	G1	8,16 kg/s ² =116 PSI	5.5 kg
TH-50	43 L	G1	8,16 kg/s ² =116 PSI	7.7 kg
TH-100	93 L	G1	8,16 kg/s ² =116 PSI	14 kg



CATÁLOGO 2024

95

* Las imágenes mostradas en este catálogo son con fines ilustrativos. IGOTO® se reserva el derecho de modificar la información sin previo aviso y no se hace responsable por omisiones o errores en este documento.

TANQUES HIDRONEUMÁTICOS

Tanques Armados

IDEAL PARA BOMBAS:

PKM-60 QB-70

Altura Máxima hasta 60 m



↑ ALTURA MÁXIMA HASTA 30m

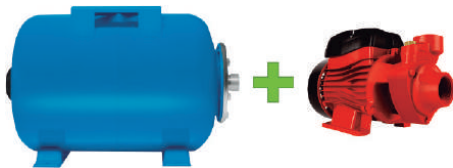

TH24 + PKM60 = HA370

↑ ALTURA MÁXIMA HASTA 60m

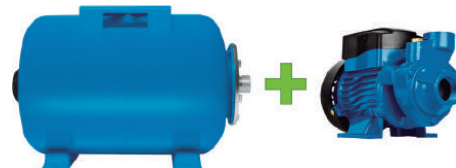

TH50 + QB70 = HA750

MODELO	Tanque	Bomba	Potencia	Capacidad real	Altura máxima	Conexión
HA370	TH24	PKM60	1/2 HP	21 L	30 m	G1
HA750	TH50	QB70	3/4 HP	43 L	60 m	G1

Automático para bomba de agua

IDEAL PARA BOMBAS:

PKM-60 QB-60 QB-70
QB-80 CPM-158D



Bombas con mínimo 3kg de presión.



Ciclo de trabajo continuo. Siempre y cuando cumpla con las condiciones óptimas de trabajo (agua y voltaje)

VENTAJAS:

MÁXIMA PRESIÓN AL ABRIR EL GRIFO DEL AGUA

- 1- Asegura la durabilidad de tus aparatos.
- 2- Regula el flujo de agua
- 3- Función automática o manual

AUTOMÁTICOS PARA BOMBAS



Ajuste de presión



AMC-2.1

Ajuste de presión



AMC-10

Ajuste de presión



AMC-12

Manómetro

MULTI VOLTAJE
85 - 240 V ~
EVITA SOBRECARGAS

PRESIÓN AJUSTABLE

SE ACTIVA CON EL FLUJO DE AGUA

MODELO	Potencia HP	Potencia W	Motor	Rango de operación	Temperatura máxima	Conexiones Succ.	Des.	Corriente eléctrica	Peso
AMC-2.1	1	750	85-240 V~	17-36 PSI	90°C	1"	1"	10 A	1.17 kg
AMC-10	1	750	85-240 V~	17-36 PSI	90°C	1"	1"	10 A	0.98 kg
AMC-12	1	750	85-240 V~	17-36 PSI	90°C	1"	1"	10 A	1.17 kg

* Las imágenes mostradas en este catálogo son con fines ilustrativos. IGOTO® se reserva el derecho de modificar la información sin previo aviso y no se hace responsable por omisiones o errores en este documento.



MOTOBOMBA

Motobomba

APLICACIONES:



Agrícola



Pipa de agua



Uso con gasolina

VENTAJAS:

IDEAL PARA AGUA LIMPIA Y REGAR CULTIVOS

- 1- Asegura la durabilidad de tus aparatos.
- 2- Sensor de nivel de aceite.

Altura Máxima hasta 32 m



Uniones para manguera de **Aluminio**

MAYOR FLUJO DE AGUA



Altura máxima **32 m**

Succión máxima **8 m**

MODELO	Potencia HP	Velocidad de motor	A. Max (m)	C. Max (l/m)	Conexión de entrada	Conexión de salida	Succión máxima	Capacidad del tanque
MAG2	6.5	3600 rpm	32	800	5 cm 2"	5 cm 2"	8 m	3.6 L
MAG3	6.5	3600 rpm	30	1200	7.6 cm 3"	8 cm 3"	8 m	3.6 L

AUTOMÁTICOS Y PRESURIZADORES

Presurizadores Automáticos

APLICACIONES:



Lavadero



Fregadero



Regadera



W.C



Lavadora



Calentador solar

VENTAJAS:

AUMENTA LA PRESIÓN DEL AGUA

- 1- Mejor conducción y menos calentamiento
- 2- Interruptor de presión de paro automático
- 3- Máximo ahorro de energía
- 4- Silencioso

Altura Máxima hasta 12 m

Llenado rápido



PAC16*

Modo de uso:
-Automático
-Manual



PAC21

EMBOBINADO DE COBRE
Mejor conducción y menos calentamiento

SE ACTIVA CON EL FLUJO DE AGUA



INCLUYE CABLE



MODELO	Potencia HP	W	Motor	Clase de asilamiento	A. Max (m)	C. Max (l/m)	Conexiones Succ.	Des.	Temperatura máxima	Corriente Eléctrica	Peso
PAC16	1/6	140	1 F 127 V~	F	11	35	3/4"	3/4"	60°C	1 A	2.5 kg
PAC21	1/6	140	1 F 127 V~	F	7	30	1"	1"	60°C	3.5 A	5 kg
	1/4	210			10.5	41	1"	1"			
	1/3	245			12	58	1"	1"			

AUTOMÁTICOS Y PREZURIZADORES

Presurizadores automáticos



Bombas con mínimo 3kg de presión.



Ciclo de trabajo continuo. Siempre y cuando cumpla con las condiciones óptimas de trabajo (agua y voltaje)

VENTAJAS:
MÁXIMA PRESIÓN AL ABRIR EL GRIFO DEL AGUA

- 1- Asegura la durabilidad de tus aparatos.
- 2- Regula el flujo de agua
- 3- Función automática o manual

Temperatura máxima
60°C
60°C

NUEVO



PAC-100

NUEVO



PAC-200



Adaptador multivoltaje



Ahorradora de energía



Silenciosa



110-220 V~
ADAPTADOR MULTIVOLTAJE

TECNOLOGÍA INVERTER

- Más caudal.
- Más potencia.
- Menos consumo.

EMBOBINADO DE COBRE
MEJOR CONDUCCIÓN Y MENOS CALENTAMIENTO

SE ACTIVA CON EL FLUJO DE AGUA

MODELO	Potencia HP	Potencia W	Motor ENTRADA	Motor SALIDA	A. Max (m)	C. Max (l/m)	Voltaje	Frecuencia	Peso
PAC-100	1/10	75	24 V~	1/2"	18 m	26 l/m	110-220V	50-60 HZ	2.5 kg
PAC-200	1/8	95	24 V~	3/4"	21 m	31 l/m	110-220V	50-60 HZ	2.5 kg

AUTOMÁTICOS Y PREZURIZADORES

Presurizadores Automáticos

APLICACIONES:



Lavadero



Fregadero



Regadera



W.C



Lavadora



Calentador solar

VENTAJAS:
AUMENTA LA PRESIÓN DEL AGUA

- 1- Mejor conducción y menos calentamiento
- 2- Interruptor de presión de paro automático
- 3- Máximo ahorro de energía
- 4- Silencioso

Altura Máxima hasta 9.2 m

Llenado rápido



PAC15*

NUEVO

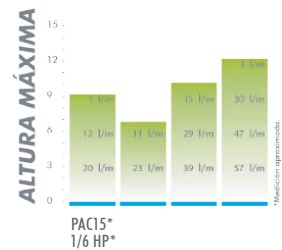

SE ACTIVA CON EL FLUJO DE AGUA

INCLUYE CABLE

MODELO	Potencia HP	Potencia W	Motor	Clase de aislamiento	A. Max (m)	C. Max (l/m)	Conexiones Succ.	Conexiones Des.	Temperatura máxima	Corriente Eléctrica	Peso
PAC15	1/6	140	1 F 127 V~	F	9	27	3/4"	3/4"	90°C	1 A	2.5 kg

* Las imágenes mostradas en este catálogo son con fines ilustrativos. IGOTO® se reserva el derecho de modificar la información sin previo aviso y no se hace responsable por omisiones o errores en este documento.





Bomba sumergible cuerpo de aluminio

Altura Máxima hasta 40 m



APLICACIONES:



VENTAJAS:
PRESIÓN CONSTANTE
A MÁXIMA ALTURA

- 1- Mejor conducción y menos calentamiento
- 2- Protege tu bomba contra el sobrecalentamiento.
- 3- Sumergible 13 m máximo



ALTO DESEMPEÑO

NUEVO

Cuerpo DE ALUMINIO

MENOR OXIDACIÓN

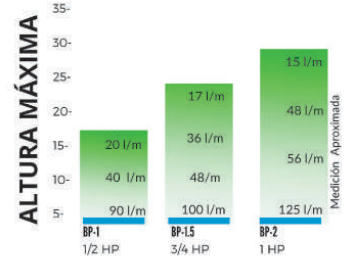

MODELO	Potencia HP	Potencia W	A. Max (m)	C. Max (l/m)	Rango H(m)	operación Q(l/m)	Conexiones Succ.	Conexiones Des.	Capacitor	Corriente eléctrica	Peso
QDA -370	0.5	0.37	16	100	15-5	20-90	1"	1"	25 µF	6.4 A	11.8 kg
QDA -550	0.75	0.55	25	108	23-5	17-100	1"	1"	40 µF	10 A	16.7 kg
QDA -750	1	0.75	31	132	29-5	15-125	1"	1"	50 uF ₁	11.8 A	16.5 kg

Bomba sumergible de acero inoxidable

Altura Máxima hasta 40 m



APLICACIONES:



VENTAJAS:
PRESIÓN CONSTANTE
A MÁXIMA ALTURA

- 1- Mejor conducción y menos calentamiento
- 2- Protege tu bomba contra el sobrecalentamiento.
- 3- Sumergible 13 m máximo



ALTO DESEMPEÑO

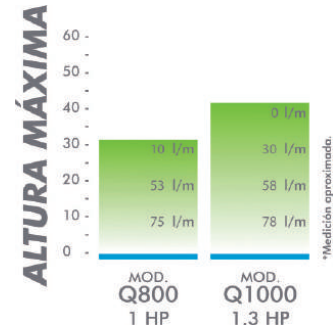

MODELO	Potencia HP	Potencia W	Impulsores	A. Max (m)	C. Max (l/m)	Rango H(m)	operación Q(l/m)	Conexiones Succ.	Conexiones Des.	Capacitor	Corriente eléctrica	Peso
Q800	1	750	3	30	296	5÷14	296÷33	1"	1"	35 µF	6 A	7.6 kg
Q1000	1.3	1100	4	40	329	7÷15	329÷50	1"	1"	35 µF	8 A	8.1 kg



BOMBAS SUMERGIBLES

Bomba sumergible plástica

Altura Máxima hasta 10 m

APLICACIONES:

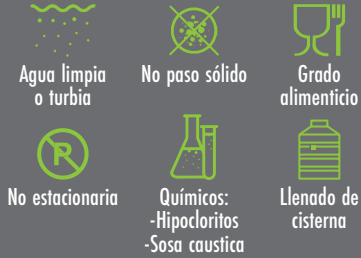

VENTAJAS:

IDEAL PARA VACIAR O BOMBEAR GRANDES CANTIDADES DE AGUA

- 1- Embobinado con protección térmica
- 2- Protege tu bomba contra el sobrecalentamiento.
- 3- Sumergible 13 m máximo



ALTO DESEMPEÑO

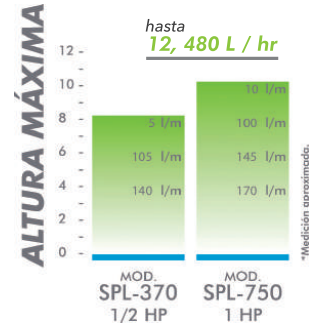

MODELO	Potencia HP	W	Motor	A. Max (m)	A. Max (l/m)	Descarga	Capacitor	Corriente eléctrica	Peso
SPL-370	1/2	370	1 F 127 V~	8	175	3/4-1" - 1/2"	10 µF	4.4 A	4.3 kg
SPL-750	1	750	1 F 127 V~	10	203	3/4-1" - 1/2"	16 µF	6.5 A	5.1 kg

Bomba sumergible para agua turbia

Altura Máxima hasta 18 m

APLICACIONES:



VENTAJAS:

MAYOR FLUJO DE AGUA

- 1- Mejor conducción y menos calentamiento
- 2- Mayor durabilidad y flujo constante
- 3- Protege tu bomba contra el sobrecalentamiento
- 4- Sumergible 13 m máximo



Salida adaptable:
- 1.5" o 2"

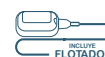
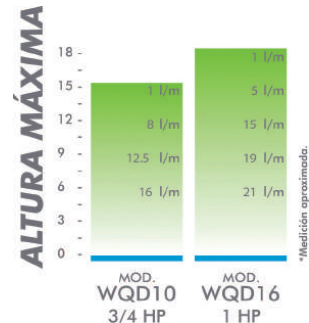

MODELO	Potencia HP	W	A. Max (m)	Descarga	Rango operación H(m)	Q(l/m)	Corriente eléctrica	Capacitor	Peso
WQD10	3/4	550	15	1.5"	5 ÷ 14	296 ÷ 33	10.6 A	40 µF	14 kg
WQD16	1	750	18	1.5"	7 ÷ 15	329 ÷ 50	12.7 A	50 µF	17 kg

* Las imágenes mostradas en este catálogo son con fines ilustrativos. IGOTO® se reserva el derecho de modificar la información sin previo aviso y no se hace responsable por omisiones o errores en este documento.



BOMBAS SUMERGIBLES

Bomba sumergible

Altura Máxima hasta 33 m



APLICACIONES:



VENTAJAS:

PRESIÓN CONSTANTE DESDE LA CISTERNA A TU HOGAR

- 1- Embobinado con protección térmica
- 2- Flujo constante
- 3- Sumergible 13 m máximo



QDX
CON FLOTADOR



QDX
SIN FLOTADOR

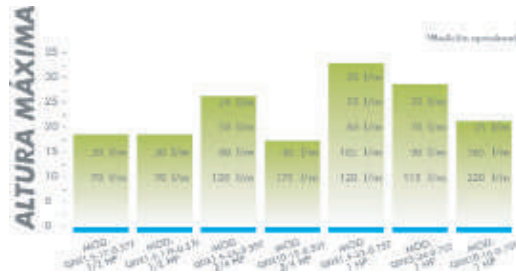

CON FLOTADOR

MODELO	Potencia HP W	Motor	A. Max (m)	Rango operación H(m)	Q(l/m)	Descarga	Capacitor	Corriente eléctrica	Peso
QDX1.5-17F-0.37F	1/2 370	1 F 127 V~	18.5	17 ÷ 6	17 ÷ 85	1"	25 µF	6.4 A	11.8 kg
QDX10-12-0.55T	3/4 550	1 F 127 V~	17.5	15 ÷ 6.5	100 ÷ 218	1 1/2"	40 µF	10 A	16.7 kg
QDX3-24-0.75T	1 750	1 F 127 V~	28	26 ÷ 12	52 ÷ 115	1 1/2"	50 µF	11.8 A	16.5 kg
QDX10-16-0.75T	1 750	1 F 127 V~	20.3	18 ÷ 7	130 ÷ 260	2"	50 µF	11.8 A	17.7 kg

SIN FLOTADOR

QDX1.5-17-0.37T	1/2 370	1 F 127 V~	18.5	17 ÷ 6	17 ÷ 85	1"	25 µF	6.4 A	11.6 kg
QDX1.5-25-0.55T	3/4 550	1 F 127 V~	25	24 ÷ 11.5	18 ÷ 110	1"	40 µF	10 A	15.6 kg
QDX1.5-32-0.75T	1 750	1 F 127 V~	33	32 ÷ 12.7	17 ÷ 112	1"	50 µF	11.8 A	17.9 kg



BOMBAS TIPO BALA

Bomba sumergible Tipo Bala

Altura Máxima hasta 192 m



APLICACIONES:



VENTAJAS:

IDEAL PARA VACIAR O BOMBEAR GRANDES CANTIDADES DE AGUA

- 1- Embobinado con protección térmica
- 2- Protege tu bomba contra el sobrecalentamiento.
- 3- Sumergible 13 m máximo



TBA



TBA220

MOTOR REBOBINABLE
BAÑADO EN ACEITE

EMBOBINADO DE COBRE
MEJOR CONDUCTIVIDAD Y MENOS CALENTAMIENTO



MODELO	Potencia HP	W	Motor	A. Max (m)	C. Max (l/m)	Conexiones Succ. Des.	Capacitor	Corriente eléctrica	Peso
TBA36	1/2	370	1 F 127 V~	50	17	1 1/4"	35 µF	5 A	10.5 kg
				39	50				
				14	83				
TBA51	3/4	550	1 F 127 V~	70	17	1 1/4"	45 µF	8 A	11.4 kg
				54	50				
				20	83				
TBA69	1	750	1 F 127 V~	90	17	1 1/4"	60 µF	11 A	12.9 kg
				76	50				
				26	83				
TBA87	1 1/2"	1100	1 F 127 V~	111	17	1 1/4"	70 µF	14 A	15 kg
				85	50				
				31	83				

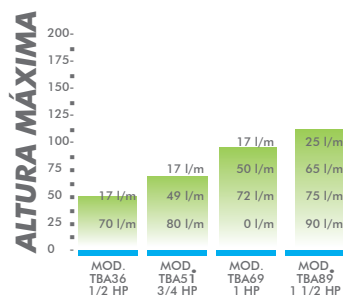

MODELO	Potencia HP	W	Motor	A. Max (m)	C. Max (l/m)	Conexiones Succ. Des.	Capacitor	Corriente eléctrica	Peso
TBA220-1.5	1.5	1.1	220 V~	85 31	50 83	1 1/4"	40 µF	6 A	- kg
TBA220-2	2	1.5	220 V~	131	17	1 1/4"	50 µF	8 A	- kg
				100	50				
				37	83				
TBA220-3	3	2.2	220 V~	195	17	1 1/4"	70 µF	14 A	- kg
				149	50				
				56	83				

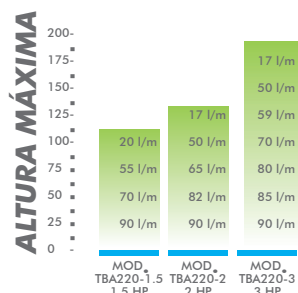

* Las imágenes mostradas en este catálogo son con fines ilustrativos. IGOTO® se reserva el derecho de modificar la información sin previo aviso y no se hace responsable por omisiones o errores en este documento.



BOMBAS TIP BALA ◀

Bomba sumergible Tipo bala con capacitor interno

Altura Máxima hasta 110 m



APLICACIONES:



Doméstico



Agrícola



Urbano



Llenado de tinaco



Ideal para pozo

VENTAJAS:

IDEAL PARA VACIAR O BOMBEAR GRANDES CANTIDADES DE AGUA

- 1- Embobinado con protección térmica
- 2- Protege tu bomba contra el sobrecalentamiento.
- 3- Sumergible 13 m máximo

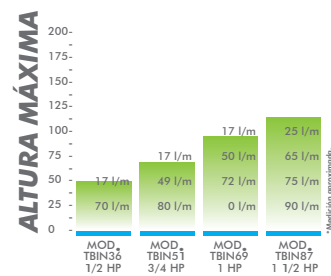

MODELO	Potencia HP	W	Motor	A. Max (m)	C. Max (l/m)	Conexiones Succ. Des.	Capacitor	Corriente eléctrica	Peso
TBIN36	1/2	370	1 F 127 V~	50	17	1 1/4"	35 µF	5 A	10.5 kg
				39	50				
				14	83				
TBIN51	3/4	550	1 F 127 V~	70	17	1 1/4"	45 µF	8 A	11.4 kg
				54	50				
				20	83				
TBIN69	1	750	1 F 127 V~	90	17	1 1/4"	60 µF	11 A	12.9 kg
				76	50				
				26	83				
TBIN87	1 1/2"	1100	1 F 127 V~	111	83	1 1/4"	70 µF	14 A	15 kg
				111	17				
				85	50				





COMPRESOR

APLICACIONES:

 Agrícola
  Doméstica

VENTAJAS:

LLENADO RÁPIDO DE AIRE

- 1- LIBRE DE MANTENIMIENTO
- 2- NO REQUIERE DE ACEITE.
- 3- PORTÁTIL Y COMPACTA
- 4- RUEDAS FIRMES, PARA FÁCIL TRANSPORTACIÓN



- 
MOTOR SILENCIOSO
- 
 Libre de mantenimiento
- 
 No requiere de aceite
- 
 Llenado rápido de aire
- 
 Salida de aire regulado / fija

MODELO	Presión máxima	Potencia	Tensión	Frecuencia	Velocidad	Flujo de aire	Capacidad de tanque
PRO -24	115PSI	1 1/2 HP	127 V~	60 Hz	3 450 rpm	190 L/min	24 L
PRO -50	115PSI	2 1/2 HP	127 V~	60 Hz	3 450 rpm	160 L/min	50 L

* Las imágenes mostradas en este catálogo son con fines ilustrativos. IGOTO® se reserva el derecho de modificar la información sin previo aviso y no se hace responsable por omisiones o errores en este documento.

COMPRESOR

APLICACIONES:



Agrícola

Doméstica

VENTAJAS:

LLENADO RÁPIDO DE AIRE

- 1- CUBIERTA PLASTICA, PROTEGE EL MOTOR.
- 2- TANQUE DE HIERRO FUNDIDO.
- 3- SOPORTE ANTIVIBRACIÓN.
- 4- PORTÁTIL Y COMPACTO.
- 5- LLENADO RAPIDO DE AIRE.

NUEVO



COMP: 10



AMBOS PRODUCTOS CONTIENEN

- 1 FILTRO DE AIRE
- TAPÓN DE DEPÓSITO DE ACEITE
- RONDANAS DE HULE
- JUEGO DE TORNILLERIA
- MANUAL DE USUARIO

NUEVO



COMP: 24



MODELO	Presión máxima	Potencia	Tención	Frecuencia	Velocidad	Flujo de aire	Capacidad de tanque
COMP-10	115PSI	2 HP	127 V~	50 Hz	3 450 rpm	160 L/min	10 L
COMP-24	115PSI	2 1/2 HP	127 V~	50 Hz	3 450 rpm	160 L/min	24 L





SOLDADORA TIPO INVERSORA
DE MICROALAMBRE MIG/ MMA / TIG

Soldadora tipo inversora de microalambre MIG/MMA/LIFT TIG

Ideal para trabajo industrial moderado



TIPO DE MICROALAMBRE
- MIG - MMA - LIFT TIG

NUEVO

VENTAJAS:

- 1- Fuerza de arco
- 2- Arranque en caliente
- 3- Tecnología anti pegado

INCLUYE:

- 1- Soldadora tipo inversora
 - 1- Cable con pinza porta electrodo
 - 1- Cable con pinza conexión a tierra
 - 1- Careta para soldar
 - 1- Cepillo de alambre
 - 1- Cable antorcha TIG
- Manual de usuario



ÚTIL PARA SOLDADURAS DE HASTA 3,2 mm

MODELO	Corriente directa	Rango de carga	Voltaje de carga	Ciclo de trabajo	Eficiencia	Factor de poder	Tipo de aislamiento	Peso
MIG-135	130 A	30-130 A	127 V~	120 A - 40% 96 A - 60%	80%	0,93	F	6,5 kg

* Las imágenes mostradas en este catálogo son con fines ilustrativos. IGOTO® se reserva el derecho de modificar la información sin previo aviso y no se hace responsable por omisiones o errores en este documento.



SOLDADORAS

Soldadora tipo inversora de microalambre MIG/MMA/LIFT TIG

Ideal para trabajo industrial moderado



TIPO DE MICROALAMBRE

- MIG - MMA - LIFT TIG

NUEVO



ÚTIL PARA SOLDADURAS DE HASTA 3,2 mm

VENTAJAS:

- 1- Fuerza de arco
- 2- Arranque en caliente
- 3- Tecnología anti pegado

INCLUYE:

- 1- Soldadora tipo inversora
- 1- Cable con pinza porta electrodo
- 1- Cable con pinza conexión a tierra
- 1- Careta para soldar
- 1- Cepillo de alambre
- 1- Cable antorcha MIG

- Manual de usuario



127-220 V~
ADAPTADOR MULTIVOLTAJE

MODELO	Corriente directa	Rango de carga	Voltaje de carga	Ciclo de trabajo	Eficiencia	Factor de poder	Tipo de aislamiento	Peso
P-135 MIG	130 A	40-120 A	127-220 V	120 A - 40% 96 A - 60%	80%	0,73	F	5 kg

Soldadora tipo inversora

Ideal para trabajo industrial ligero



TIPO DE ELECTRODOS

- Revestido - Microalambre - Tungsteno



5 minutos de trabajo continuo por 5 minutos de descanso

VENTAJAS:

- 1- Aprovechamiento de energía
- 2- Convierte corriente alterna a corriente directa

INCLUYE:

- 1- Soldadora tipo inversora
- 1- Cable con pinza porta electrodo
- 1- Cable con pinza conexión a tierra
- 1- Careta para soldar
- 1- Cepillo de alambre
- Manual de usuario

MINI-130 - Uso amateur

MINI-200 - Uso semiprofesional



MULTI VOLTAJE
110 - 240 V~
EVITA SOBRECARGAS



ÚTIL PARA SOLDADURAS DE HASTA 3,2 mm



MODELO	Corriente directa	Rango de carga	Voltaje de carga	Ciclo de trabajo	Eficiencia	Factor de poder	Tipo de aislamiento	Peso
MINI-130	130 A	30-130 A	67 V~	50%	80%	0,93	F	4 kg
MINI-200	200 A	30-200 A	67 V~	50%	80%	0,93	F	5,5 kg



➤ SOLDADORAS

Soldadora tipo inversora plus

TIPO DE ELECTRODOS

- Revestido - Microalambre
- Tungsteno

5/5

5 minutos de trabajo continuo por 5 minutos de descanso

VENTAJAS:

- 1- Aprovechamiento de energía
- 2- Convierte corriente alterna a corriente directa

INCLUYE:

- 1- Soldadora tipo inversora
- 1- Cable con pinza porta electrodo
- 1- Cable con pinza conexión a tierra
- 1- Careta para soldar
- 1- Cepillo de alambre
- Manual de usuario

Ideal para trabajo industrial moderado



PLUS-130

VOLTAJE 110 V ~

PLUS-200

MULTI VOLTAJE 110 - 240 V ~
EVITA SOBRECARGAS

MODELO	Corriente directa	Rango de carga	Voltaje de carga	Ciclo de trabajo	Eficiencia	Factor de poder	Tipo de aislamiento	Peso
PLUS-130	130 A	30-130 A	67 V~	50%	80%	0,93	F	4 kg
PLUS-200	200 A	30-200 A	67 V~	50%	80%	0,93	F	5.5 kg

Careta electrónica

Careta Electrónica de Oscurecimiento Automático

Protección UV / IR

Batería **Li-Ion**
Carga mediante celda solar

ENCENDIDO Y APAGADO ELECTRÓNICO



MODELO	Protección	Nivel de sombra	Sensores de arco	Ideal para soldaduras	Velocidad de retardo	Peso
CRT01	UV/IR	DIN 11	2	TIG/MIG/MAG	0,2-0,5 s	0,46 kg
CRT11	UV/IR	DIN 9-13	2	TIG/MIG/MAG	0,2- 1 s	0,46 kg
CRT03	UV/IR	DIN 11	2	TIG/MIG/MAG	0,2- 1 s	0,47 kg
CRT12	UV/IR	DIN 11	2	TIG/MIG/MAG	0,2- 1 s	0,46 kg
CRT13	UV/IR	DIN 11	2	TIG/MIG/MAG	0,2- 1 s	0,46 kg

* Las imágenes mostradas en este catálogo son con fines ilustrativos. IGOTO® se reserva el derecho de modificar la información sin previo aviso y no se hace responsable por omisiones o errores en este documento.





Flotador con contra peso



Policarbonato

Cable de cobre

Frecuencia 60 Hz

MODELO	Longitud manguera	Corriente eléctrica	Peso
FPS-2	2 m	16 A	0.3 kg
FPS-3	3 m	16 A	0.6 kg
FPS-6	6 m	16 A	0.9 kg
FPS-10	10 m	16 A	1.2 kg

Tarjeta para control automático

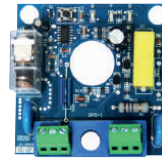

R-AMC-2.1

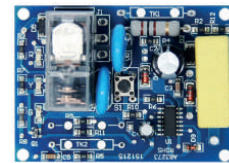

R-AMC-10



R-AMC-12

MODELO	Descripción	Apto para
R-AMC-2.1	Refacción pastilla AMC-2.1	AMC-2.1
R-AMC-10	Refacción pastilla AMC-10	AMC-10
R-AMC-12	Refacción pastilla AMC-12	AMC-12

Impulsor para bomba centrífuga y pérfica

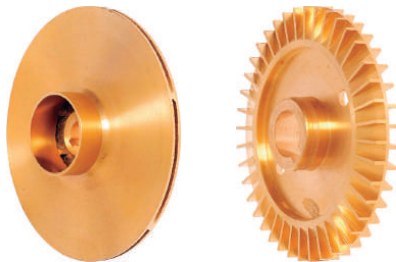

MODELO	Apto para	MODELO	Apto para
REF-04	CPM130D	REF-18	QB60
REF-05	CPM146D	REF-19	QB70
REF-06	CPM158D	REF-44	QB80

Impulsor para bomba sumergible



MODELO	Capacidad	MODELO	Capacidad
REF-20	QDX17	REF-23	QDX32
REF-21	QDX25	REF-24	QDX24
REF-22	QDX12	REF-25	QDX16



➤ **REFACCIONES**

Membrana EPDM



MODELO	Apto para
REF-33	Tanque 24 L



MODELO	Apto para
REF-34	Tanque 50 L



MODELO	Apto para
REF-35	Tanque 100 L

Conector



MODELO
REF-01

Manómetro



MODELO
REF-36

Tapa capicitor para PK60



MODELO
REF-29

Control automático para tanque hidroneumático



MODELO	Motor	Rango operación	Corriente eléctrica	Entrada conexión
AMH-2	85-240 V~	20-40 PSI	16 A	1/4"

Manguera flexible



MODELO	Medida
REF-03	60 cm

* Las imágenes mostradas en este catálogo son con fines ilustrativos. IGOTO® se reserva el derecho de modificar la información sin previo aviso y no se hace responsable por omisiones o errores en este documento.



REFACCIONES

Ventilador

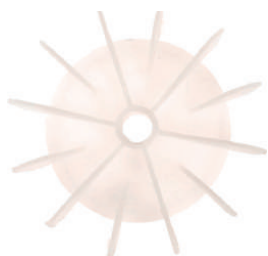

MODELO	Apto para
REF-07	QB60,PKM60,CPM-130
REF-08	QB70,QB80
REF-09	CPM146,CPM158

Inyector



MODELO	Capacidad
REF-30	JINX60
REF-31	JINX70
REF-32	JINX80, JINX90

Capacitor



MODELO	Capacidad	MODELO	Capacidad
REF-10	20 μ F	REF-13	25 μ F
REF-11	30 μ F	REF-14	35 μ F
REF-12	40 μ F	REF-15	45 μ F

Balero



MODELO	Apto para
REF-26	QB70 y QB80
REF-27	QB60,QDX17,CPM-130 AT60
REF-28	QDX25,QDX12,CPM-146 CPM-158, AT80, QDX32 QD16

Sello mecánico



MODELO	Apto para
REF-16	QB60,QB70,PKM60,CPM-130
REF-17	CPM-146,CPM-158

Caja de control



MODELO	Apto para
REF-37	TBA-36
REF-38	TBA-51
REF-39	TBA-69
REF-40	TBA-87
REF-41	TBA-220-1.5
REF-42	TBA-220-2
REF-43	TBA-220-3

SWISS
PUMPS

igoto[®]

